

Sterilization Container Systems

Secure Today
Elevate Tomorrow



SANITEV

www.sanitev.com

SANNI

The logo for Sanitev, featuring the word "SANITEV" in a bold, blue, sans-serif font. The letters are partially cut off on the left side. The text is centered between two thick, light gray horizontal bars that extend across the width of the page.

SANITEV

Sanitev retains the right to modify and enhance the products showcased in this catalogue as part of its ongoing development efforts. All provided weight and dimensional information is approximate and may vary from the actual products.





Table Of Contents

06	INTRODUCTION	15
16	STANDARD MODELS	35
36	REUSABLE MODELS	57
58	STERILIZATION BASKETS	67
68	ACCESSORIES & COMPONENTS	69
70	TROLLEYS & TABLES	71
72	INDEX	73

SANITEV

The Full Story

Sanitev is more than a healthcare supply company; it is a testament to resilience, integrity, and a strong commitment to human values. Founded by two industry professionals who shared a vision of building an organization that prioritizes people alongside sustainable growth, our journey began within the global medical device industry.

Inspired by real-world challenges, Sanitev was created to become not only a successful company in the sector, but also a symbol of ethics, responsibility, and compassion. We believe that true success is not measured solely by financial performance, but by the positive impact we make on our employees, partners, and the communities we serve.



Our Vision

At Sanitev, our vision is to become a leading provider of healthcare solutions, recognized not only for the quality of our products but also for our unwavering commitment to the well-being of our employees, partners, and the communities we serve.

We envision a future where healthcare is defined not only by cutting-edge technology, but also by compassionate, ethical, and responsible practices — setting new standards of trust and excellence across the industry.

Our Mission

At Sanitev, our mission is twofold. First, to deliver exceptional healthcare products designed to enhance the quality of life for individuals undergoing medical procedures — for both human and veterinary applications.

Second, to build a corporate culture that places the well-being of our team members at the center of everything we do, recognizing our people as the true driving force behind our success. We are committed to fostering a diverse, inclusive, and respectful working environment, upholding human rights, and acting as a role model for responsible, ethical, and sustainable business practices across the healthcare industry.

Precision in Form, Compliance in Function

R&D

Experience the innovation driving Sanitev through our dedicated Research and Development (R&D) division. Our expert R&D team is committed to advancing healthcare technology by continuously developing cutting-edge solutions that address the evolving needs of both human and veterinary applications.

By utilizing advanced technologies and refined methodologies, combined with rigorous testing and continuous improvement processes, we ensure that every product meets the highest standards of quality, safety, and performance. Our relentless pursuit of excellence enables us to deliver reliable, future-ready healthcare solutions you can trust.

Production

Discover the excellence behind Sanitev's production processes, designed to deliver precision, efficiency, and uncompromising quality. Our state-of-the-art manufacturing techniques are engineered to ensure consistent outcomes, guaranteeing that each product complies with strict safety and reliability standards.

Operating within a 2,000-square-meter closed production facility, we integrate modern technologies with streamlined workflows to maximize productivity while minimizing downtime. With meticulous quality control at every stage, Sanitev remains committed to delivering superior reliability and operational excellence in every product we manufacture.

Regulatory & Quality

At Sanitev, our unwavering commitment to quality, safety, and regulatory compliance — including full adherence to internationally recognized standards such as CE, FDA, and ISO — forms the foundation of everything we do.

Our Regulatory Affairs & Quality Assurance (RA/QA) Department, operating at the core of our business, ensures that every product consistently meets both global regulations and the highest benchmarks for safety, performance, and reliability.

In the medical and veterinary industries, quality is non-negotiable. That is why our RA/QA professionals rigorously oversee all stages of product development, manufacturing, and distribution, applying meticulous controls to guarantee compliance with strict regulatory requirements and industry best practices.

Navigating the complexity of international regulatory frameworks demands precision and expertise. Our experienced regulatory affairs specialists remain fully updated on evolving global regulations, managing the processes required to obtain and maintain necessary certifications, approvals, and registrations from regulatory bodies including CE, FDA, ISO, and other relevant authorities.

In addition, our strong commitment to Occupational Health and Safety is fully integrated into our operational culture, safeguarding the well-being of our workforce while reinforcing the quality and integrity of every product we deliver.

Technical Competencies

- Machining
- Subtractive Manufacturing
- Deep Drawing
- Die & Mold Making
- Chemical Coating
- Hard Anodization
- Silicone Forming
- Laser Welding
- OEM - ODM - PLM

Sterilization Container Systems

SANITEV



Special Stackability Design

2 mm Aluminium Bottom & Lid

OEM-PLM Marking Option



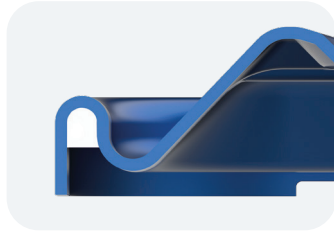

Place and Go Gasket

 Shape / No Glue

Double-Button
Extra-Secure Lock

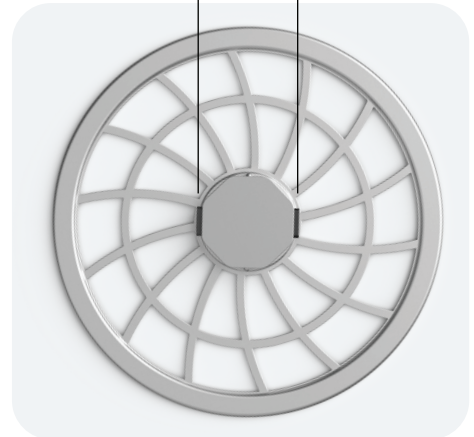

Filter Retainer With
Sealing & Spring System

Spring-Loaded Aluminium
Lock for
Better Grip and Sealing

Face Plate Made of
Single Block of Aluminium

Extra-Strong Silicone Coated
Ergonomic Handles





Different Lids Colors

Our sterilization containers at Victoris come in eight different colors (silver, yellow, red, blue, green, black, bronze and purple) ensuring to easily distinguish between different sets or types of instruments at a glance.





Advantages of Multiple Colors

- **Enhanced Organization:** Different colors can be used to categorize and organize instruments based on their usage, department, or level of sterilization, reducing the risk of cross-contamination and improving efficiency..
- **Easy Identification:** Color-coding helps in quickly identifying the contents of each container, saving time and reducing errors in busy environments.
- **Improved Workflow:** With a clear visual system in place, staff can more easily manage inventory and ensure that the right instruments are always in the right place.

Customized Solutions & Tailored to Your Needs

Sanitev sterilization containers are manufactured in eight main sizes to meet a wide range of surgical requirements.

Standard formats – 1/1 Full Size, 3/4 Size, 1/2 Half Size, Mini, Dental, and 1/2 Dental Size – are ideal for routine surgical instrument sets.

The Wide Body size is specially designed to accommodate large or complex instruments such as Bookwalter retractors, while the Long Body size is optimized for extended instruments including robotic surgical arms and long surgical tools.

Our containers are available in five standard height options, ensuring compatibility with instruments of varying dimensions. In addition, custom sizes and height configurations can be produced upon request to precisely meet specific surgical or institutional requirements.

Standard 5 Different Heights
For Standard & Reusable Models



Extra
Long Size



Extra
Wide Size

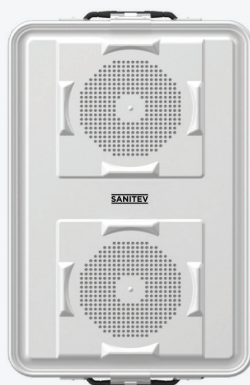

1/1
Full Size



3/4
Quarter Size



1/2
Half Size



1/2 Dental Size



Dental Size



Mini Size

Standard 8 Different Size Types
For Standard & Reusable Models

Type	Packaging according to EN 868-8		Steam sterilization procedure according to EN 285				
	Description	Symbolic Packaging	Gravity	Pre-Vacuum	Fractional Vacuum	Fractional Flow	Steam Injection
Sterilization Container with filters	Textiles in container with filter in lid and box		+	+	+	+	+
			O	O	+	+	+
	Textiles in container with filter in lid, non-perforated box		-	-	+	+	+
			-	-	+	+	O
	Textiles in container with filter in box, non-perforated lid		O	+	+	+	+
			-	O	+	+	+
	Instruments in wire basket, in sterilization filter in lid and box		+3	+	+	+	+
	Instruments in wire basket, in sterilization container filter in lid and non-perforated box		-	+2	+2	+2	+2
Instruments in wire basket, in sterilization container filter in box and non-perforated lid		O	+	+	+	+	
Sterilization Container with valves	Textiles in sterilization container with valves in lid and box		-	O	+	+	O
			-	-	+	+	O
	Textiles in sterilization container with valves in lid and no valves on the box		-	-	+	+	-
			-	-	+	+	-
	Instruments in wire basket in sterilization container with valve in lid and box		-	+2	+2	+2	+2
	Instruments in wire basket, in sterilization container with valve in lid and non-perforated box		-	+2	+2	+2	+2

*To prevent errors during service, operation, or loading of the autoclaves, consult above table.

*Use only sterilization containers that guarantee proper evaporation or discharge of condensate.

*Keep in mind that gravitation-based procedures, which lack a dedicated drying process, do not ensure sufficient after-drying effects.

STANDARD & REUSABLE MODELS

SECURE TODAY

ELEVATE TOMORROW





WHY STERILIZATION CONTAINERS?

Consistent Processing

Reduced Risk of Contamination

Physical Instrument Protection

Optimal Set Organization

Reusability / Sustainability

Reduced Waste

Streamlined Process

Easy Identification and Access

Adherence to Standards

Minimized Handling

Standard Model

Sterilization Container Systems

SANITEV

Today's Safety.
Tomorrow's Efficiency



 Different Lids
Colors

victorishealth.com

Elevated Sterilization Solutions: For Your Operational Excellence

Discover our 2mm special alloy aluminum container systems that provide superior protection for your surgical instruments. Available in 8 different color palettes, they facilitate organization and quick identification. This solution supports your operational excellence by combining reliability, an eco-friendly approach, and long-term cost advantages.

SAFETY LIDS



TWO DIFFERENT FILTER TYPES

Paper Filter or PTFE Filter



EASE WITH COLORS
EXCELLENCE IN WORKFLOW



8 Different Lids Colors



TWO BOTTOM TYPES



Non Perforated



Perforated



Standard Model

1/1 Full Size

 Different Lids Colors



With Safety Lid



With Perforated Lid



Non Perforated



Perforated

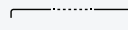

Code	Outside Dimension Inside Dimension L x W x H	Code	Outside Dimension Inside Dimension L x W x H
K1-10-110	595 x 270 x 95 mm 544 x 257 x 92 mm	KP1-10-110	595 x 270 x 95 mm 544 x 257 x 80 mm
K1-10-135	595 x 270 x 115 mm 544 x 257 x 113 mm	KP1-10-135	595 x 270 x 115 mm 544 x 257 x 101 mm
K1-10-150	595 x 270 x 140 mm 544 x 257 x 137 mm	KP1-10-150	595 x 270 x 140 mm 544 x 257 x 125 mm
K1-10-200	595 x 270 x 190 mm 544 x 257 x 187 mm	KP1-10-200	595 x 270 x 190 mm 544 x 257 x 175 mm
K1-10-260	595 x 270 x 250 mm 544 x 257 x 247 mm	KP1-10-260	595 x 270 x 250 mm 544 x 257 x 235 mm

 **Lids**

 **Safety Lids**



Colors	Code
Grey	K1-10-1
Yellow	K1-10-2
Red	K1-10-3
Blue	K1-10-4
Green	K1-10-5
Black	K1-10-6
Purple	K1-10-7
Bronze	K1-10-8

Dimension
585 x 285 mm

Colors	Code
Grey	KS1-10-1
Yellow	KS1-10-2
Red	KS1-10-3
Blue	KS1-10-4
Green	KS1-10-5
Black	KS1-10-6
Purple	KS1-10-7
Bronze	KS1-10-8

Dimension
605 x 287 mm

Wire Basket



Box

Code	Outside Dimension L x W x H
B1-5425-30	540 x 255 x 30 mm
B1-5425-50	540 x 255 x 50 mm
B1-5425-70	540 x 255 x 70 mm
B1-5425-100	540 x 255 x 100 mm

Mesh: 4x4 mm
Wire: ø 1 mm



Lid

Code	Outside Dimension L x W x H
B1-5425	510 x 240 x 5 mm

Perforated Basket



Box (with 10 mm feet)

Code	Outside Dimension L x W x H
B2-5425-30	540 x 253 x 40 mm
B2-5425-50	540 x 253 x 60 mm
B2-5425-70	540 x 253 x 80 mm
B2-5425-100	540 x 253 x 110 mm

Mesh: 4x4 mm
Wire: ø 1 mm



Lid

Code	Outside Dimension L x W x H
B2-5425	540 x 256 x 5 mm

Hybrid Basket



Box

Code	Outside Dimension L x W x H
B3-5425-50	540 x 255 x 50 mm
B3-5425-70	540 x 255 x 70 mm
B3-5425-100	540 x 255 x 100 mm

Mesh: 4x4 mm
Sides: ø 3 mm
Wire: ø 1 mm



Lid

Code	Outside Dimension L x W x H
B1-5425	540 x 255 x 5 mm

Silicone Mat

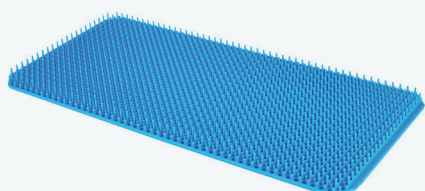

Code	Outside Dimension L x W x H
A7-5425	500 x 235 mm

Standard Model

1/1 Full Size Baskets

Wire Basket

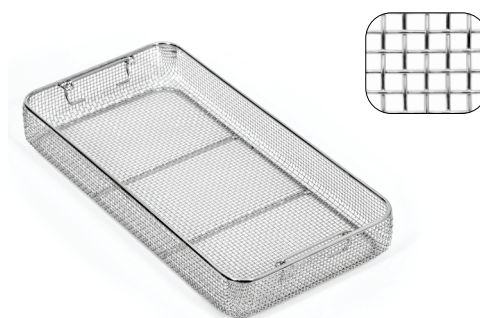

Perforated Basket

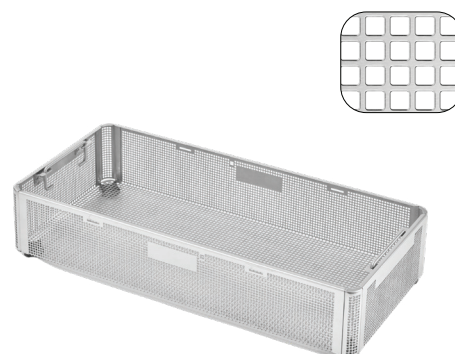

Hybrid Basket



Standard Model

3/4 Quarter Size

 Different Lids Colors



With Safety Lid



With Perforated Lid



Non Perforated



Perforated



Code	Outside Dimension Inside Dimension L x W x H
K1-20-110	470 x 270 x 95 mm 430 x 260 x 92 mm
K1-20-135	470 x 270 x 115 mm 430 x 260 x 101 mm
K1-20-150	470 x 270 x 140 mm 430 x 260 x 137 mm
K1-20-200	470 x 270 x 184 mm 430 x 260 x 178 mm

Code	Outside Dimension Inside Dimension L x W x H
KP1-20-110	470 x 270 x 95 mm 430 x 260 x 80 mm
KP1-20-135	470 x 270 x 115 mm 430 x 260 x 101 mm
KP1-20-150	470 x 270 x 140 mm 430 x 260 x 125 mm
KP1-20-200	470 x 270 x 184 mm 430 x 260 x 166 mm

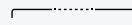

Lids



Safety Lids



Colors	Code
Grey	K1-20-1
Yellow	K1-20-2
Red	K1-20-3
Blue	K1-20-4
Green	K1-20-5
Black	K1-20-6
Purple	K1-20-7
Bronze	K1-20-8

Dimension
465 x 285 mm

Colors	Code
Grey	KS1-20-1
Yellow	KS1-20-2
Red	KS1-20-3
Blue	KS1-20-4
Green	KS1-20-5
Black	KS1-20-6
Purple	KS1-20-7
Bronze	KS1-20-8

Dimension
482 x 287 mm

Wire Basket



Mesh: 4x4 mm
Wire: ø 1 mm



Code	Outside Dimension L x W x H
B1-4025-30	405 x 255 x 30 mm
B1-4025-50	405 x 255 x 50 mm
B1-4025-70	405 x 255 x 70 mm
B1-4025-100	405 x 255 x 100 mm

Code	Outside Dimension L x W x H
B1-4025	375 x 240 x 5 mm

Perforated Basket



Mesh: 4x4 mm
Wire: ø 1 mm



Code	Outside Dimension L x W x H
B2-4025-30	405 x 252 x 40 mm
B2-4025-50	405 x 252 x 60 mm
B2-4025-70	405 x 252 x 80 mm
B2-4025-100	405 x 252 x 110 mm

Code	Outside Dimension L x W x H
B2-4025	409 x 256 x 5 mm

Hybrid Basket



Mesh: 4x4 mm
Sides: ø 3 mm
Wire: ø 1 mm



Code	Outside Dimension L x W x H
B3-4025-50	405 x 245 x 50 mm
B3-4025-70	405 x 245 x 70 mm
B3-4025-100	405 x 245 x 100 mm

Code	Outside Dimension L x W x H
B1-4025	405 x 245 x 5 mm

Silicone Mat

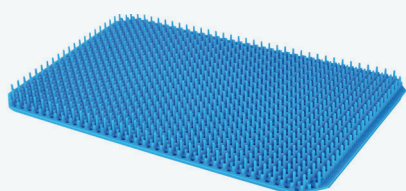

Code	Outside Dimension L x W x H
A7-4025	370 x 235 mm

Standard Model

3/4 Quarter Size Baskets

Wire Basket

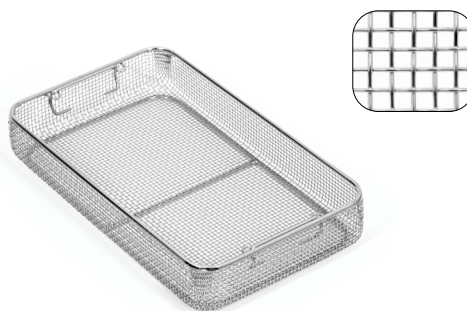

Perforated Basket

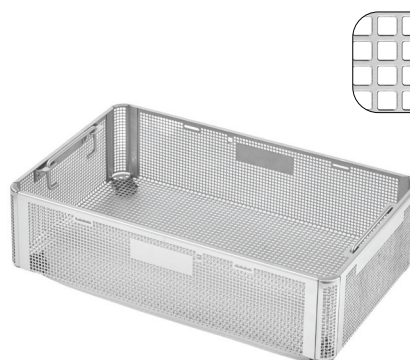

Hybrid Basket



Standard Model

1/2 Half Size

 Different Lids Colors



With Safety Lid



With Perforated Lid



Non Perforated



Perforated



Code	Outside Dimension Inside Dimension L x W x H
K1-30-110	300 x 270 x 95 mm 255 x 255 x 92 mm
K1-30-135	300 x 270 x 115 mm 255 x 255 x 113 mm
K1-30-150	300 x 270 x 140 mm 255 x 255 x 137 mm
K1-30-200	300 x 270 x 190 mm 255 x 255 x 187 mm
K1-30-260	300 x 270 x 250 mm 255 x 255 x 247 mm

Code	Outside Dimension Inside Dimension L x W x H
KP1-30-110	300 x 270 x 95 mm 255 x 255 x 80 mm
KP1-30-135	300 x 270 x 115 mm 255 x 255 x 101 mm
KP1-30-150	300 x 270 x 140 mm 255 x 255 x 125 mm
KP1-30-200	300 x 270 x 190 mm 255 x 255 x 175 mm
KP1-30-260	300 x 270 x 250 mm 255 x 255 x 235 mm



Lids



Safety Lids



Colors	Code
Grey	K1-30-1
Yellow	K1-30-2
Red	K1-30-3
Blue	K1-30-4
Green	K1-30-5
Black	K1-30-6
Purple	K1-30-7
Bronze	K1-30-8

Dimension
295 x 285 mm

Colors	Code
Grey	KS1-30-1
Yellow	KS1-30-2
Red	KS1-30-3
Blue	KS1-30-4
Green	KS1-30-5
Black	KS1-30-6
Purple	KS1-30-7
Bronze	KS1-30-8

Dimension
315 x 287 mm

Wire Basket



Box

Code	Outside Dimension L x W x H
B1-2525-30	255 x 245 x 30 mm
B1-2525-50	255 x 245 x 50 mm
B1-2525-70	255 x 245 x 70 mm
B1-2525-100	255 x 245 x 100 mm

Mesh: 4x4 mm
Wire: ø 1 mm



Lid

Code	Outside Dimension L x W x H
B1-2525	240 x 215 x 5 mm

Perforated Basket



Box (with 10 mm feet)

Code	Outside Dimension L x W x H
B2-2525-30	242 x 252 x 40 mm
B2-2525-50	242 x 252 x 60 mm
B2-2525-70	242 x 252 x 80 mm
B2-2525-100	242 x 252 x 110 mm

Mesh: 4x4 mm
Wire: ø 1 mm



Lid

Code	Outside Dimension L x W x H
B2-2525	246 x 256 x 5 mm

Hybrid Basket



Box

Code	Outside Dimension L x W x H
B3-2525-50	255 x 245 x 50 mm
B3-2525-70	255 x 245 x 70 mm
B3-2525-100	255 x 245 x 100 mm

Mesh: 4x4 mm
Sides: ø 3 mm
Wire: ø 1 mm



Lid

Code	Outside Dimension L x W x H
B1-2525	245 x 245 x 5 mm

Silicone Mat

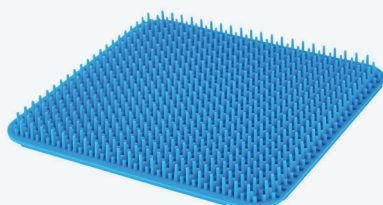

Code	Outside Dimension L x W x H
A7-2525	225 x 235 mm

Standard Model

1/2 Half Size Baskets

Wire Basket

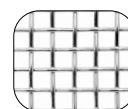

Perforated Basket

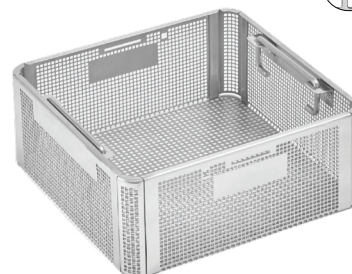
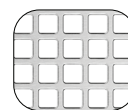

Hybrid Basket

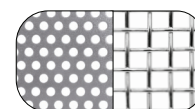

Standard Model

Long Size

 Different Lids Colors



With Perforated Lid



With Color Options



Non Perforated



Perforated



Code	Outside Dimension Inside Dimension L x W x H	Code	Outside Dimension Inside Dimension L x W x H
K1-40-150	770 x 270 x 135 mm 720 x 260 x 130 mm	KP1-40-150	770 x 270 x 135 mm 720 x 260 x 118 mm
K1-40-200	770 x 270 x 190 mm 720 x 260 x 185 mm	KP1-40-200	770 x 270 x 190 mm 720 x 260 x 173 mm

Lids



Colors	Code
Grey	K1-40-1
Yellow	K1-40-2
Red	K1-40-3
Blue	K1-40-4
Green	K1-40-5
Black	K1-40-6
Purple	K1-40-7
Bronze	K1-40-8

Dimension
755 x 285 mm

Wire Basket



Mesh: 4x4 mm
Wire: ø 1 mm



Box



Lid

Code	Outside Dimension L x W x H
B1-6625-50	665 x 250 x 50 mm
B1-6625-70	665 x 250 x 70 mm
B1-6625-100	665 x 250 x 100 mm

Code	Outside Dimension L x W x H
B1-6625	635 x 235 x 5 mm

Perforated Basket



Mesh: 4x4 mm
Wire: ø 1 mm



Box (with 10 mm feet)

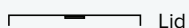

Lid

Code	Outside Dimension L x W x H
B2-6625-30	665 x 253 x 40 mm
B2-6625-50	665 x 253 x 60 mm
B2-6625-70	665 x 253 x 80 mm
B2-6625-100	665 x 253 x 110 mm

Code	Outside Dimension L x W x H
B2-6625	668 x 256 x 5 mm

Hybrid Basket



Mesh: 4x4 mm
Sides: ø 3 mm
Wire: ø 1 mm



Box



Lid

Code	Outside Dimension L x W x H
B3-6625-50	665 x 245 x 50 mm
B3-6625-70	665 x 245 x 70 mm
B3-6625-100	665 x 245 x 100 mm

Code	Outside Dimension L x W x H
B1-6625	668 x 256 x 5 mm

Standard Model

Long Size Baskets

Wire Basket

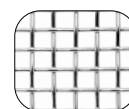
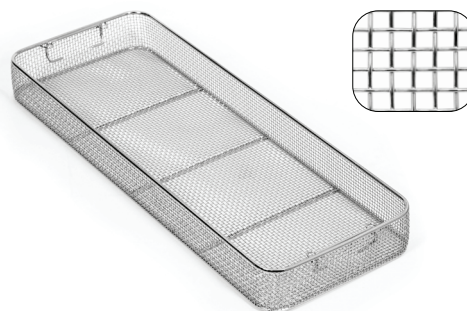

Perforated Basket

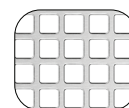
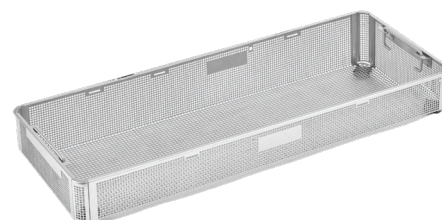

Hybrid Basket

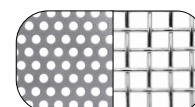

Standard Model

Wide Size

 Different Lids Colors



With Perforated Lid



With Color Options

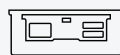

Non Perforated



Perforated



Code	Outside Dimension Inside Dimension L x W x H	Code	Outside Dimension Inside Dimension L x W x H
K1-50-110	595 x 365 x 105 mm 545 x 352 x 100 mm	KP1-50-110	595 x 365 x 105 mm 545 x 352 x 88 mm
K1-50-170	595 x 365 x 165 mm 545 x 352 x 160mm	KP1-50-170	595 x 365 x 165 mm 545 x 352 x 148 mm

Lids



Colors	Code
Grey	K1-50-1
Yellow	K1-50-2
Red	K1-50-3
Blue	K1-50-4
Green	K1-50-5
Black	K1-50-6
Purple	K1-50-7
Bronze	K1-50-8

Dimension
585 x 370 mm

Standard Model

Wide Size Baskets

Wire Basket

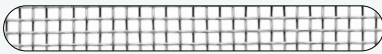

Mesh: 4x4 mm
Wire: ø 1 mm



Box



Lid

Code	Outside Dimension L x W x H
B1-5333-50	533 x 337 x 50 mm
B1-5333-70	533 x 337 x 70 mm
B1-5333-100	533 x 337 x 100 mm

Code	Outside Dimension L x W x H
B1-5333	533 x 337 x 5 mm

Wire Basket

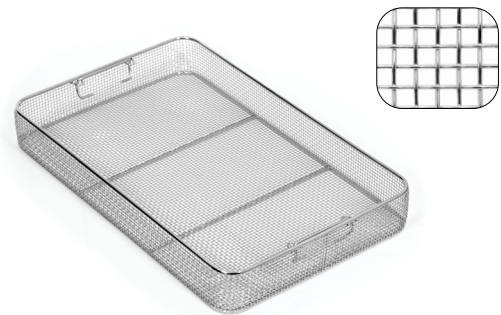

Perforated Basket



Mesh: 4x4 mm
Wire: ø 1 mm

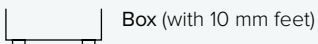

Box (with 10 mm feet)



Lid

Code	Outside Dimension L x W x H
B2-5333-30	533 x 339 x 40 mm
B2-5333-50	533 x 339 x 60 mm
B2-5333-70	533 x 339 x 80 mm
B2-5333-100	533 x 339 x 110 mm

Code	Outside Dimension L x W x H
B2-5333	534 x 343 x 5 mm

Perforated Basket

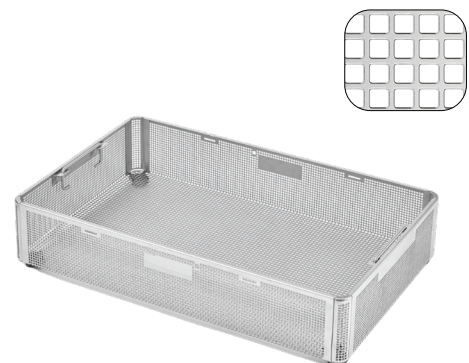

Hybrid Basket



Mesh: 4x4 mm
Sides: ø 3 mm
Wire: ø 1 mm

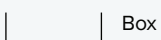

Box



Lid

Code	Outside Dimension L x W x H
B3-5333-50	533 x 337 x 50 mm
B3-5333-70	533 x 337 x 70 mm
B3-5333-100	533 x 337 x 100 mm

Code	Outside Dimension L x W x H
B1-5333	533 x 337 x 5 mm

Hybrid Basket



Standard Model

Flat Size

 Different Lids Colors



With Perforated Lid



With Color Options



Non Perforated



Code **Outside Dimension**
Inside Dimension
L x W x H

K1-90-45 295 x 270 x 45 mm
 255 x 255 x 41 mm

K1-90-75 295 x 270 x 75 mm
 255 x 255 x 71 mm

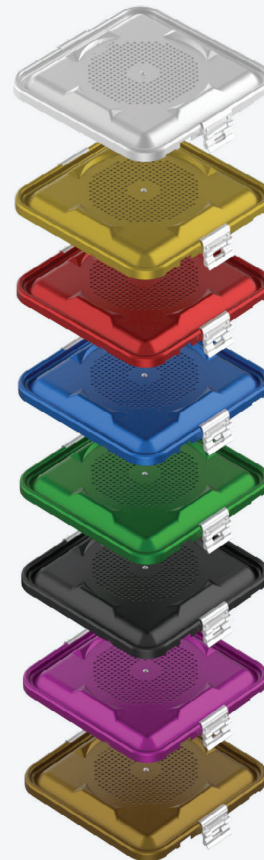

 **Lids**

Colors **Code**

Grey K1-90-1

Yellow K1-90-2

Red K1-90-3

Blue K1-90-4

Green K1-90-5

Black K1-90-6

Purple K1-90-7

Bronze K1-90-8

Dimension
295 x 285 mm

Standard Model

Flat Size Baskets

Wire Basket



Mesh: 4x4 mm
Wire: ø 1 mm



Box



Lid

Code **Outside Dimension**
L x W x H

B1-2525-30 255 x 245 x 30 mm

B1-2525-50 255 x 245 x 50 mm

Code

B1-2525

Outside Dimension
L x W x H

240 x 215 x 5 mm

Wire Basket

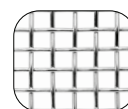

Perforated Basket



Mesh: 4x4 mm
Wire: ø 1 mm



Box (with 10 mm feet)



Lid

Code **Outside Dimension**
L x W x H

B2-2525-30 242 x 252 x 40 mm

B2-2525-50 242 x 252 x 60 mm

Code

B2-2525

Outside Dimension
L x W x H

246 x 256 x 5 mm

Perforated Basket

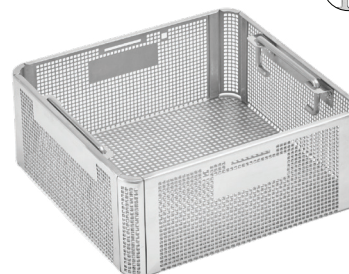
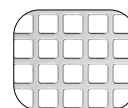

Silicone Mat

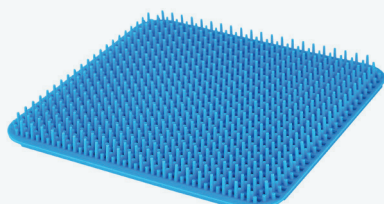

Code

A7-2525

Outside Dimension
L x W x H

225 x 235 mm

Standard Model

Mini Size

 Different Lids Colors



With Perforated Lid



With Color Options



Non Perforated

Code	Outside Dimension	
	Inside Dimension L x W x H	
K1-70-40	315 x 130 x 40 mm	275 x 127 x 30 mm
K1-70-70	315 x 130 x 70 mm	275 x 127 x 60 mm
K1-70-100	315 x 130 x 100 mm	275 x 127 x 90 mm
K1-70-130	315 x 130 x 130 mm	275 x 127 x 120 mm

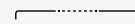

Lids



Colors	Code
Grey	K1-70-1
Yellow	K1-70-2
Red	K1-70-3
Blue	K1-70-4
Green	K1-70-5
Black	K1-70-6
Purple	K1-70-7
Bronze	K1-70-8

Dimension
315 x 130 mm

Standard Model

Mini Size Baskets

Wire Basket



Mesh: 4x4 mm
Wire: ø 1 mm



Box



Lid

Code **Outside Dimension**
L x W x H

B1-2712-40 270 x 117 x 40 mm

B1-2712-100 268 x 117 x 100 mm

Code

B1-2712

Outside Dimension
L x W x H

270 x 117 x 5 mm

Wire Basket

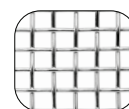

Perforated Basket



Mesh: 4x4 mm
Wire: ø 1 mm



Box (with 10 mm feet)

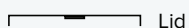

Lid

Code **Outside Dimension**
L x W x H

B2-2712-40 265 x 125 x 50 mm

B2-2712-100 265 x 125 x 110 mm

Code

B2-2712

Outside Dimension
L x W x H

268 x 128 x 5 mm

Perforated Basket

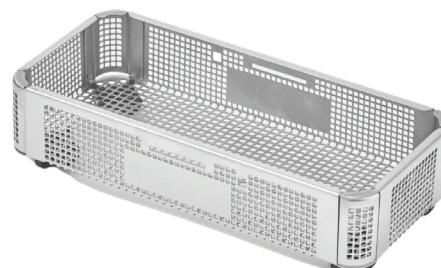
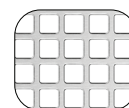

Silicone Mat

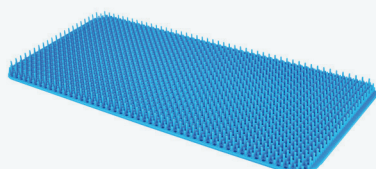

Code

A7-2712

Outside Dimension
L x W x H

270 x 125 mm

Standard Model

Dental Size

 Different Lids Colors



With Perforated Lid



With Color Options



Non Perforated

Code **Outside Dimension**
Inside Dimension
L x W x H

K1-60-40	320 x 185 x 40 mm 280 x 182 x 30 mm
K1-60-70	320 x 185 x 70 mm 280 x 182 x 40 mm
K1-60-100	320 x 185 x 100 mm 280 x 182 x 90 mm
K1-60-130	320 x 185 x 130 mm 280 x 182 x 120 mm

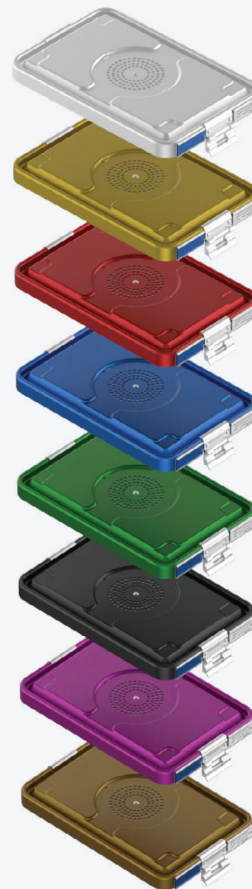

Lids

Colors	Code
Grey	K1-60-1
Yellow	K1-60-2
Red	K1-60-3
Blue	K1-60-4
Green	K1-60-5
Black	K1-60-6
Purple	K1-60-7
Bronze	K1-60-8

Dimension
325 x 190 mm

Standard Model

Dental Size Baskets

Wire Basket

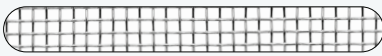

Mesh: \varnothing 4x4 mm
Wire: \varnothing 1 mm



Box



Lid

Code	Outside Dimension L x W x H
B1-2717-40	270 x 170 x 40 mm
B1-2717-100	270 x 170 x 100 mm

Code	Outside Dimension L x W x H
B1-2717	270 x 170 x 5 mm

Wire Basket

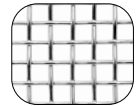

Perforated Basket



Mesh: \varnothing 4x4 mm
Wire: \varnothing 1 mm



Box (with 10 mm feet)



Lid

Code	Outside Dimension L x W x H
B2-2717-40	275 x 175 x 50 mm
B2-2717-100	275 x 175 x 110 mm

Code	Outside Dimension L x W x H
B2-2717	278 x 178 x 5 mm

Perforated Basket

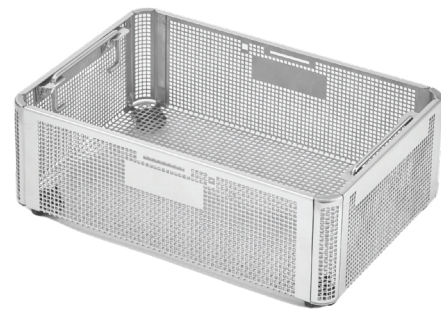
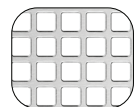

Standard Model

1/2 Dental Size

 Different Lids Colors



With Perforated Lid



With Color Options



Non Perforated



Code **Outside Dimension**
Inside Dimension
L x W x H

K1-80-40	225 x 160 x 40 mm 190 x 157 x 30 mm
K1-80-70	225 x 160 x 70 mm 190 x 157 x 60 mm
K1-80-100	225 x 160 x 100 mm 190 x 157 x 90 mm
K1-80-130	225 x 160 x 130 mm 190 x 157 x 120 mm

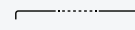

 **Lids**

Colors **Code**

Grey	K1-80-1
Yellow	K1-80-2
Red	K1-80-3
Blue	K1-80-4
Green	K1-80-5
Black	K1-80-6
Purple	K1-80-7
Bronze	K1-80-8

Dimension
230 x 175 mm

Standard Model

1/2 Dental Size Baskets

Wire Basket

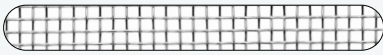

Mesh: \varnothing 4x4 mm
Wire: \varnothing 1 mm



Box



Lid

Code **Outside Dimension**
L x W x H

B1-1714-40 175 x 145 x 40 mm

B1-1714-100 175 x 145 x 100 mm

Code

B1-1714

Outside Dimension
L x W x H

175 x 145 x 5 mm

Wire Basket

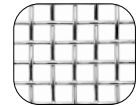

Perforated Basket

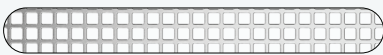

Mesh: \varnothing 4x4 mm
Wire: \varnothing 1 mm

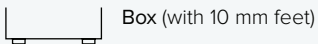

Box (with 10 mm feet)



Lid

Code **Outside Dimension**
L x W x H

B2-1714-40 175 x 145 x 50 mm

B2-1714-100 175 x 145 x 110 mm

Code

B2-1714

Outside Dimension
L x W x H

178 x 148 x 5 mm

Perforated Basket

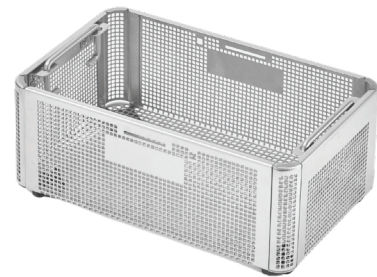
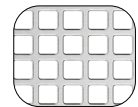

Clean. Safe. Sustainable.

2 Different Filtering System
Mechanical Valve System & Barrier System



Reduce Reuse Renew



 Different Lids
Colors

BARRIER MODEL

The Barrier Model is an innovative sterilization container designed to ensure maximum safety in CSSD workflows. Its labyrinth structure prevents microorganisms from entering, maintaining sterility for extended periods. This design offers reliable, practical, and scientifically proven protection.

BARRIER FILTERS

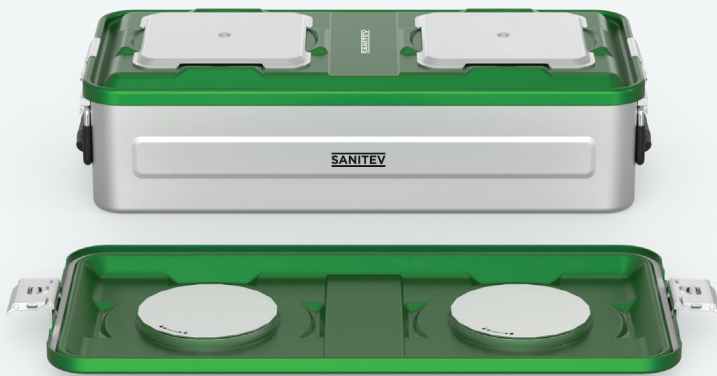

EASY-TO-USE LOCK / UNLOCK

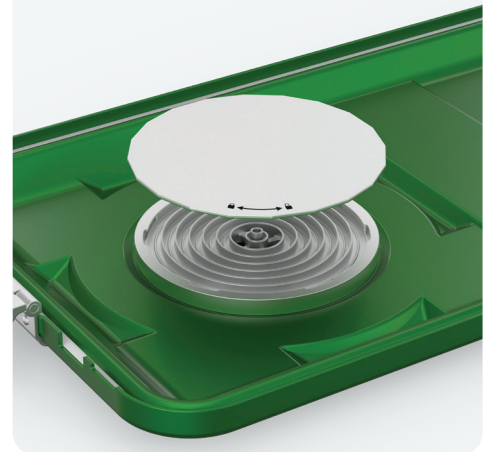

STEAM FILTER CROSS-SECTIONAL VIEW

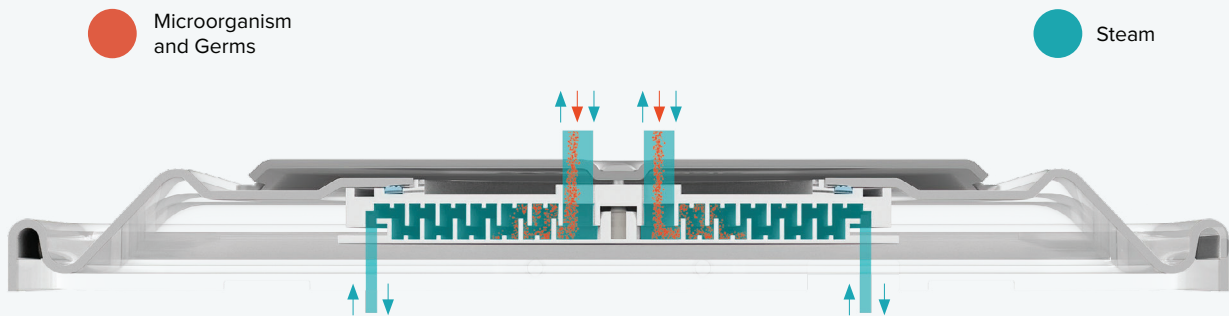

**EASE WITH COLORS
EXCELLENCE IN WORKFLOW**

8 Different Lids Colors



Scientific Foundation

The principle behind the Barrier mechanism traces back to Louis Pasteur’s groundbreaking “Swan Neck Flask” experiment in 1862, which challenged the idea of spontaneous generation. Pasteur designed a flask with an S-shaped neck that allowed air to pass freely but trapped dust and microorganisms in its curves. When the broth inside was boiled and left untouched, no microbial growth occurred, clearly proving that life could not emerge without contamination from existing microorganisms. However, once the flask was tilted and the trapped particles reached the broth, microbial growth appeared almost immediately.

The Barrier Model adopts the same principle through its labyrinth-like system. By forcing air to travel through a complex path, it prevents microorganisms and viruses from penetrating the container. This ensures that sterility is maintained, while still allowing necessary airflow. The result is a reliable and scientifically validated protective system, directly inspired by one of the most important experiments in microbiology.

Reusable Model

Sterilization Container Systems

SANITEV

REDUCE. REUSE. RENEW.

Seize Cost Control and Sustainability: Ditch the waste expense and embrace the smart, permanent solution.



Reduce



Reuse



Renew



VALVE MODEL

Sanitev Valve Model sterilization containers are designed with an advanced mechanical valve system that eliminates the need for disposable filters while ensuring stable and reliable performance throughout prolonged use. Each valve is precisely engineered with integrated sealing gaskets that respond smoothly to pressure changes during the sterilization cycle, guaranteeing consistent airflow regulation. The secure closure system, reinforced by high-grade silicone gaskets, delivers superior sealing integrity and long-term durability. By combining innovative engineering with ergonomic practicality, Sanitev Valve Model containers provide a sustainable, efficient, and cost-effective solution for safe and effective sterilization in healthcare facilities worldwide.

EASE WITH COLORS EXCELLENCE IN WORKFLOW

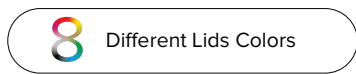

RUNNING PRINCIPLE

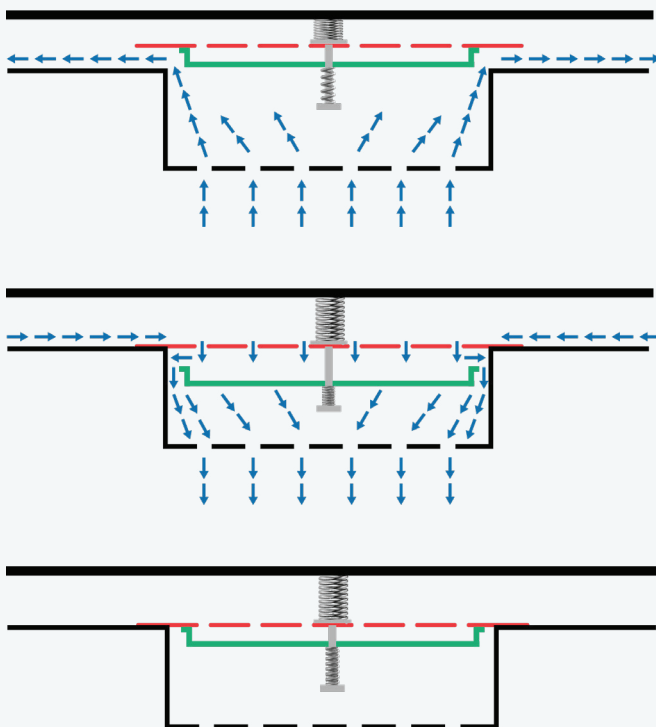

At the beginning of the sterilization cycle, the vacuum phase causes the valves to fully open, allowing the evacuation of dry air from the container.

During the sterilization cycle, the pressure-activated valves automatically open under positive pressure, enabling controlled steam penetration for effective sterilization.

Once the process is complete, and no external forces such as vacuum or pressure are present, the entire system remains sealed, preserving the sterility of its contents.

Reusable Model

1/1 Full Size

 Different Lids Colors



With Reusable Mechanism



With Color Options

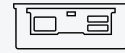

Non Perforated

Code **Outside Dimension**
Inside Dimension
L x W x H

K1-10-110	595 x 270 x 95 mm 544 x 257 x 92 mm
K1-10-135	595 x 270 x 115 mm 544 x 257 x 113 mm
K1-10-150	595 x 270 x 140 mm 544 x 257 x 137 mm
K1-10-200	595 x 270 x 190 mm 544 x 257 x 187 mm
K1-10-260	595 x 270 x 250 mm 544 x 257 x 247 mm



 **Valve Lids**

Colors **Code**

Grey	K2-10-1
Yellow	K2-10-2
Red	K2-10-3
Blue	K2-10-4
Green	K2-10-5
Black	K2-10-6
Purple	K2-10-7
Bronze	K2-10-8

Dimension
585 x 285 mm

 **Barrier Lids**

Colors **Code**

Grey	K3-10-1
Yellow	K3-10-2
Red	K3-10-3
Blue	K3-10-4
Green	K3-10-5
Black	K3-10-6
Purple	K3-10-7
Bronze	K3-10-8

Dimension
585 x 285 mm

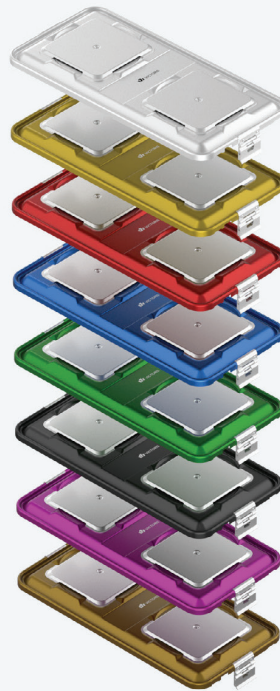

Wire Basket



Box

Code	Outside Dimension L x W x H
B1-5425-30	540 x 255 x 30 mm
B1-5425-50	540 x 255 x 50 mm
B1-5425-70	540 x 255 x 70 mm
B1-5425-100	540 x 255 x 100 mm

Mesh: 4x4 mm
Wire: ø 1 mm



Lid

Code	Outside Dimension L x W x H
B1-5425	510 x 240 x 5 mm

Perforated Basket



Box (with 10 mm feet)

Code	Outside Dimension L x W x H
B2-5425-30	540 x 253 x 40 mm
B2-5425-50	540 x 253 x 60 mm
B2-5425-70	540 x 253 x 80 mm
B2-5425-100	540 x 253 x 110 mm

Mesh: 4x4 mm
Wire: ø 1 mm



Lid

Code	Outside Dimension L x W x H
B2-5425	540 x 256 x 5 mm

Hybrid Basket



Box

Code	Outside Dimension L x W x H
B3-5425-50	540 x 255 x 50 mm
B3-5425-70	540 x 255 x 70 mm
B3-5425-100	540 x 255 x 100 mm

Mesh: 4x4 mm
Sides: ø 3 mm
Wire: ø 1 mm



Lid

Code	Outside Dimension L x W x H
B1-5425	540 x 255 x 5 mm

Silicone Mat

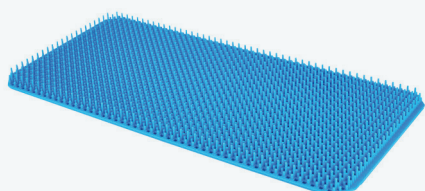

Code	Outside Dimension L x W x H
A7-5425	500 x 235 mm

Reusable Model

1/1 Full Size Baskets

Wire Basket

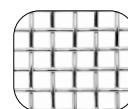

Perforated Basket

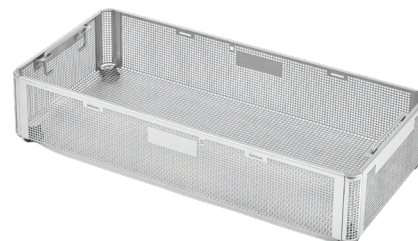
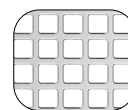

Hybrid Basket

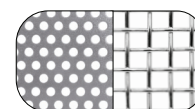

Reusable Model

3/4 Quarter Size

 Different Lids Colors



With Reusable Mechanism



With Color Options



Non Perforated

Code **Outside Dimension**
 Inside Dimension
 L x W x H

K1-20-110	470 x 270 x 95 mm 430 x 260 x 92 mm
K1-20-135	470 x 270 x 115 mm 430 x 260 x 101 mm
K1-20-150	470 x 270 x 140 mm 430 x 260 x 137 mm
K1-20-200	470 x 270 x 184 mm 430 x 260 x 178 mm



 **Valve Lids**

Colors **Code**

Grey	K2-20-1
Yellow	K2-20-2
Red	K2-20-3
Blue	K2-20-4
Green	K2-20-5
Black	K2-20-6
Purple	K2-20-7
Bronze	K2-20-8

Dimension
465 x 285 mm

 **Barrier Lids**

Colors **Code**

Grey	K3-20-1
Yellow	K3-20-2
Red	K3-20-3
Blue	K3-20-4
Green	K3-20-5
Black	K3-20-6
Purple	K3-20-7
Bronze	K3-20-8

Dimension
465 x 285 mm



Wire Basket



Box

Code	Outside Dimension L x W x H
B1-4025-30	405 x 255 x 30 mm
B1-4025-50	405 x 255 x 50 mm
B1-4025-70	405 x 255 x 70 mm
B1-4025-100	405 x 255 x 100 mm

Mesh: 4x4 mm
Wire: ø 1 mm



Lid

Code	Outside Dimension L x W x H
B1-4025	375 x 240 x 5 mm

Perforated Basket



Box (with 10 mm feet)

Code	Outside Dimension L x W x H
B2-4025-30	405 x 252 x 40 mm
B2-4025-50	405 x 252 x 60 mm
B2-4025-70	405 x 252 x 80 mm
B2-4025-100	405 x 252 x 110 mm

Mesh: 4x4 mm
Wire: ø 1 mm



Lid

Code	Outside Dimension L x W x H
B2-4025	409 x 256 x 5 mm

Hybrid Basket



Box

Code	Outside Dimension L x W x H
B3-4025-50	405 x 245 x 50 mm
B3-4025-70	405 x 245 x 70 mm
B3-4025-100	405 x 245 x 100 mm

Mesh: 4x4 mm
Sides: ø 3 mm
Wire: ø 1 mm

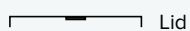

Lid

Code	Outside Dimension L x W x H
B1-4025	405 x 245 x 5 mm

Silicone Mat

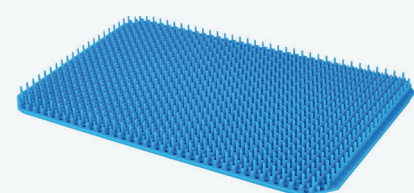

Code	Outside Dimension L x W x H
A7-4025	370 x 235 mm

Reusable Model

3/4 Quarter Size Baskets

Wire Basket

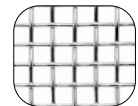

Perforated Basket

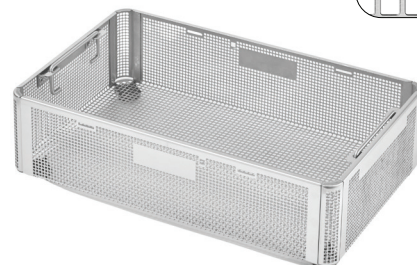
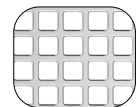

Hybrid Basket

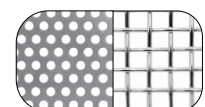

Reusable Model

1/2 Half Size

 Different Lids Colors



With Reusable Mechanism



With Color Options



Non Perforated



Code	Outside Dimension Inside Dimension L x W x H
K1-30-110	300 x 270 x 95 mm 255 x 255 x 92 mm
K1-30-135	300 x 270 x 115 mm 255 x 255 x 113 mm
K1-30-150	300 x 270 x 140 mm 255 x 255 x 137 mm
K1-30-200	300 x 270 x 190 mm 255 x 255 x 187 mm
K1-30-260	300 x 270 x 250 mm 255 x 255 x 247 mm

 **Valve Lids**

Colors	Code
Grey	K2-30-1
Yellow	K2-30-2
Red	K2-30-3
Blue	K2-30-4
Green	K2-30-5
Black	K2-30-6
Purple	K2-30-7
Bronze	K2-30-8

Dimension
295 x 285 mm

 **Barrier Lids**

Colors	Code
Grey	K3-30-1
Yellow	K3-30-2
Red	K3-30-3
Blue	K3-30-4
Green	K3-30-5
Black	K3-30-6
Purple	K3-30-7
Bronze	K3-30-8

Dimension
295 x 285 mm

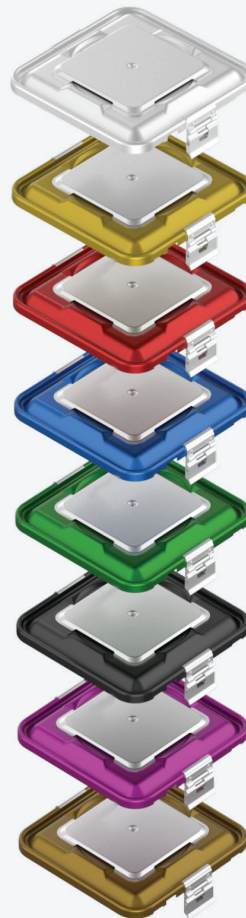

Wire Basket



Box

Code	Outside Dimension L x W x H
B1-2525-30	255 x 245 x 30 mm
B1-2525-50	255 x 245 x 50 mm
B1-2525-70	255 x 245 x 70 mm
B1-2525-100	255 x 245 x 100 mm

Mesh: 4x4 mm
Wire: ø 1 mm



Lid

Code	Outside Dimension L x W x H
B1-2525	240 x 215 x 5 mm

Perforated Basket



Box (with 10 mm feet)

Code	Outside Dimension L x W x H
B2-2525-30	242 x 252 x 40 mm
B2-2525-50	242 x 252 x 60 mm
B2-2525-70	242 x 252 x 80 mm
B2-2525-100	242 x 252 x 110 mm

Mesh: 4x4 mm
Wire: ø 1 mm



Lid

Code	Outside Dimension L x W x H
B2-2525	246 x 256 x 5 mm

Hybrid Basket



Box

Code	Outside Dimension L x W x H
B3-2525-50	255 x 245 x 50 mm
B3-2525-70	255 x 245 x 70 mm
B3-2525-100	255 x 245 x 100 mm

Mesh: 4x4 mm
Sides: ø 3 mm
Wire: ø 1 mm



Lid

Code	Outside Dimension L x W x H
B1-2525	245 x 245 x 5 mm

Silicone Mat

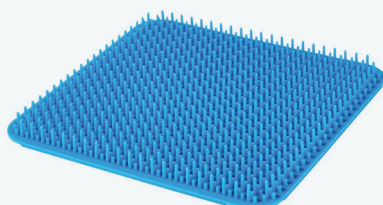

Code	Outside Dimension L x W x H
A7-2525	225 x 235 mm

Reusable Model

1/2 Half Size Baskets

Wire Basket

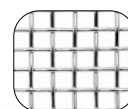

Perforated Basket

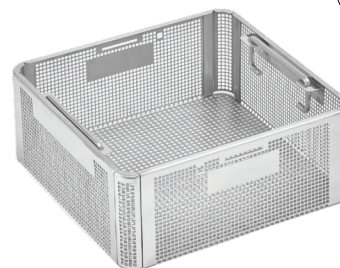
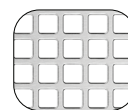

Hybrid Basket

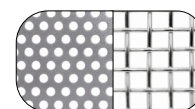

Reusable Model

Long Size

 Different Lids Colors



With Reusable Mechanism



With Color Options



Code	Outside Dimension
	Inside Dimension L x W x H
K1-40-150	770 x 270 x 135 mm
	720 x 260 x 130 mm
K1-40-200	770 x 270 x 190 mm
	720 x 260 x 185 mm



 **Valve Lids**

Colors	Code
Grey	K2-40-1
Yellow	K2-40-2
Red	K2-40-3
Blue	K2-40-4
Green	K2-40-5
Black	K2-40-6
Purple	K2-40-7
Bronze	K2-40-8

Dimension
770 x 270 mm



 **Barrier Lids**

Colors	Code
Grey	K3-40-1
Yellow	K3-40-2
Red	K3-40-3
Blue	K3-40-4
Green	K3-40-5
Black	K3-40-6
Purple	K3-40-7
Bronze	K3-40-8

Dimension
770 x 270 mm

Wire Basket



Mesh: 4x4 mm
Wire: ø 1 mm



Box



Lid

Code	Outside Dimension L x W x H
B1-6625-50	665 x 250 x 50 mm
B1-6625-70	665 x 250 x 70 mm
B1-6625-100	665 x 250 x 100 mm

Code	Outside Dimension L x W x H
B1-6625	635 x 235 x 5 mm

Perforated Basket



Mesh: 4x4 mm
Wire: ø 1 mm



Box (with 10 mm feet)

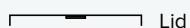

Lid

Code	Outside Dimension L x W x H
B2-6625-30	665 x 253 x 40 mm
B2-6625-50	665 x 253 x 60 mm
B2-6625-70	665 x 253 x 80 mm
B2-6625-100	665 x 253 x 110 mm

Code	Outside Dimension L x W x H
B2-6625	668 x 256 x 5 mm

Hybrid Basket



Mesh: 4x4 mm
Sides: ø 3 mm
Wire: ø 1 mm



Box



Lid

Code	Outside Dimension L x W x H
B3-6625-50	665 x 245 x 50 mm
B3-6625-70	665 x 245 x 70 mm
B3-6625-100	665 x 245 x 100 mm

Code	Outside Dimension L x W x H
B1-6625	668 x 256 x 5 mm

Reusable Model

Long Size Baskets

Wire Basket

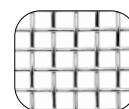
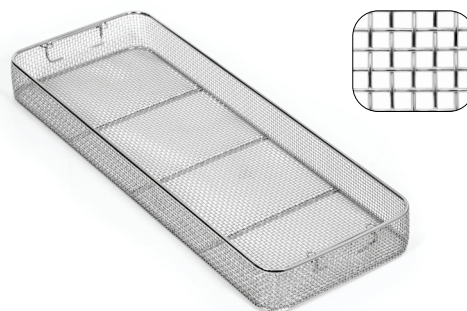

Perforated Basket

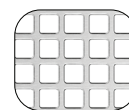
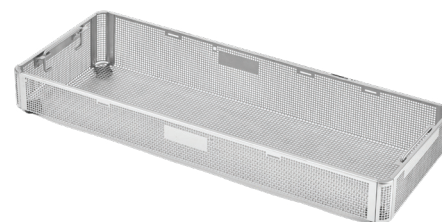

Hybrid Basket

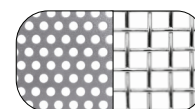

Reusable Model

Wide Size

 Different Lids Colors



With Reusable Mechanism



With Color Options



Code	Outside Dimension
	Inside Dimension L x W x H
K1-50-110	595 x 365 x 105 mm 545 x 352 x 100 mm
K1-50-170	595 x 365 x 165 mm 545 x 352 x 160mm

 **Valve Lids**

Colors	Code
Grey	K2-50-1
Yellow	K2-50-2
Red	K2-50-3
Blue	K2-50-4
Green	K2-50-5
Black	K2-50-6
Purple	K2-50-7
Bronze	K2-50-8

Dimension
585 x 370 mm

 **Barrier Lids**

Colors	Code
Grey	K3-50-1
Yellow	K3-50-2
Red	K3-50-3
Blue	K3-50-4
Green	K3-50-5
Black	K3-50-6
Purple	K3-50-7
Bronze	K3-50-8

Dimension
585 x 370 mm

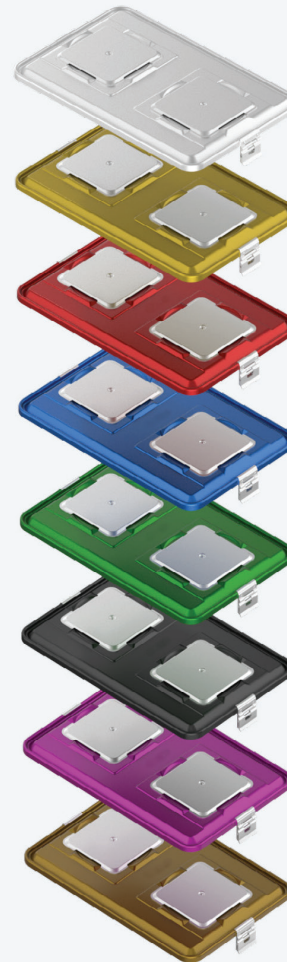

Wire Basket

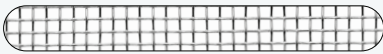

Mesh: 4x4 mm
Wire: ø 1 mm



Box

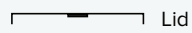

Lid

Code	Outside Dimension L x W x H
B1-5333-50	533 x 337 x 50 mm
B1-5333-70	533 x 337 x 70 mm
B1-5333-100	533 x 337 x 100 mm

Code	Outside Dimension L x W x H
B1-5333	533 x 337 x 5 mm

Perforated Basket



Mesh: 4x4 mm
Wire: ø 1 mm



Box (with 10 mm feet)



Lid

Code	Outside Dimension L x W x H
B2-5333-30	533 x 339 x 40 mm
B2-5333-50	533 x 339 x 60 mm
B2-5333-70	533 x 339 x 80 mm
B2-5333-100	533 x 339 x 110 mm

Code	Outside Dimension L x W x H
B2-5333	534 x 343 x 5 mm

Hybrid Basket



Mesh: 4x4 mm
Sides: ø 3 mm
Wire: ø 1 mm



Box



Lid

Code	Outside Dimension L x W x H
B3-5333-50	533 x 337 x 50 mm
B3-5333-70	533 x 337 x 70 mm
B3-5333-100	533 x 337 x 100 mm

Code	Outside Dimension L x W x H
B1-5333	533 x 337 x 5 mm

Reusable Model

Wide Size Baskets

Wire Basket

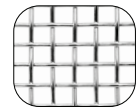
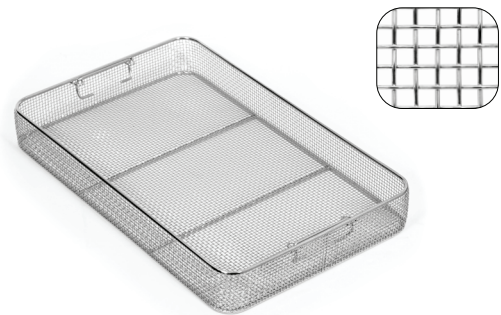

Perforated Basket

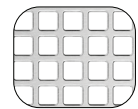
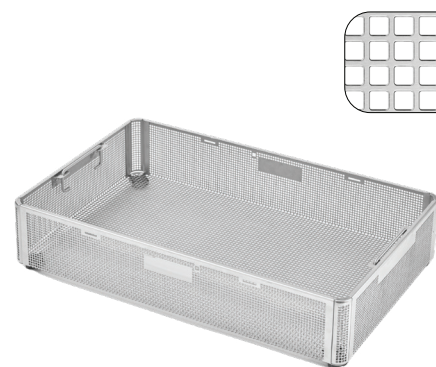

Hybrid Basket

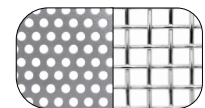

Reusable Model

Flat Size

 Different Lids Colors



With Reusable Mechanism



With Color Options

 Non Perforated



Code	Outside Dimension
	Inside Dimension L x W x H
K1-90-75	295 x 270 x 75 mm 255 x 255 x 71 mm



 Lids

Colors	Code
Grey	K3-90-1
Yellow	K3-90-2
Red	K3-90-3
Blue	K3-90-4
Green	K3-90-5
Black	K3-90-6
Purple	K3-90-7
Bronze	K3-90-8

Dimension
295 x 285 mm

Reusable Model

Flat Size Baskets

Wire Basket



Mesh: 4x4 mm
Wire: ø 1 mm



Box



Lid

Code **Outside Dimension**
L x W x H

B1-2525-30 255 x 245 x 30 mm

B1-2525-50 255 x 245 x 50 mm

Code

B1-2525

Outside Dimension
L x W x H

240 x 215 x 5 mm

Wire Basket

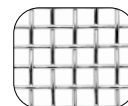

Perforated Basket



Mesh: 4x4 mm
Wire: ø 1 mm



Box (with 10 mm feet)



Lid

Code **Outside Dimension**
L x W x H

B2-2525-30 242 x 252 x 40 mm

B2-2525-50 242 x 252 x 60 mm

Code

B2-2525

Outside Dimension
L x W x H

246 x 256 x 5 mm

Perforated Basket

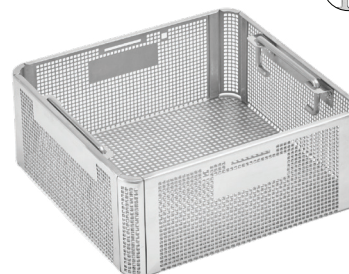
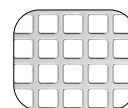

Silicone Mat

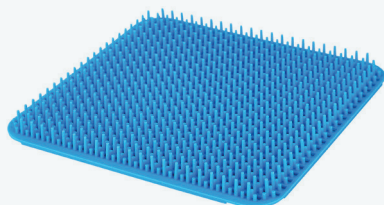

Code

A7-2525

Outside Dimension
L x W x H

225 x 235 mm

Reusable Model

Mini Size

 Different Lids Colors



With Reusable Mechanism



With Color Options



Non Perforated

Code **Outside Dimension**
Inside Dimension
L x W x H

K1-70-70 315 x 130 x 70 mm
275 x 127 x 60 mm

K1-70-100 315 x 130 x 100 mm
275 x 127 x 90 mm

K1-70-130 315 x 130 x 130 mm
275 x 127 x 120 mm

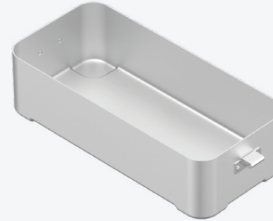

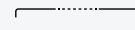
 **Lids**

Colors **Code**

Grey K3-70-1

Yellow K3-70-2

Red K3-70-3

Blue K3-70-4

Green K3-70-5

Black K3-70-6

Purple K3-70-7

Bronze K3-70-8

Dimension
315 x 130 mm



Reusable Model

Mini Size Baskets

Wire Basket

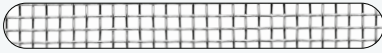

Mesh: 4x4 mm
Wire: ø 1 mm



Box



Lid

Code **Outside Dimension**
 L x W x H

B1-2712-40 270 x 117 x 40 mm

B1-2712-100 268 x 117 x 100 mm

Code

B1-2712

Outside Dimension
L x W x H

270 x 117 x 5 mm

Wire Basket

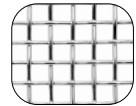

Perforated Basket



Mesh: 4x4 mm
Wire: ø 1 mm



Box (with 10 mm feet)

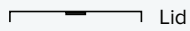

Lid

Code **Outside Dimension**
 L x W x H

B2-2712-40 265 x 125 x 50 mm

B2-2712-100 265 x 125 x 110 mm

Code

B2-2712

Outside Dimension
L x W x H

268 x 128 x 5 mm

Perforated Basket

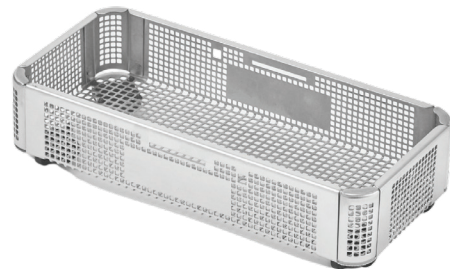
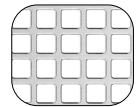

Silicone Mat

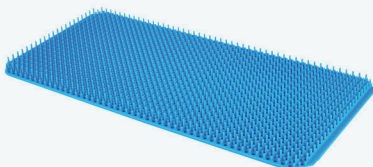

Code

A7-2712

Outside Dimension
L x W x H

270 x 125 mm

Reusable Model

Dental Size

 Different Lids Colors



With Reusable Mechanism

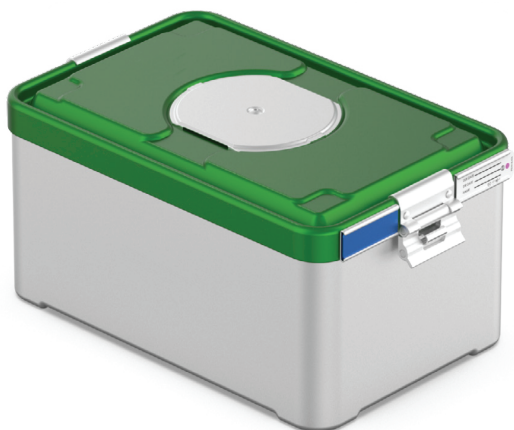

With Color Options



Non Perforated

Code	Outside Dimension Inside Dimension L x W x H
------	--

K1-60-70	320 x 185 x 70 mm 280 x 182 x 40 mm
----------	--

K1-60-100	320 x 185 x 100 mm 280 x 182 x 90 mm
-----------	---

K1-60-130	320 x 185 x 130 mm 280 x 182 x 120 mm
-----------	--

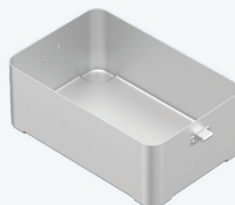

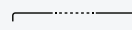
 Lids

Colors	Code
--------	------

Grey	K3-60-1
------	---------

Yellow	K3-60-2
--------	---------

Red	K3-60-3
-----	---------

Blue	K3-60-4
------	---------

Green	K3-60-5
-------	---------

Black	K3-60-6
-------	---------

Purple	K3-60-7
--------	---------

Bronze	K3-60-8
--------	---------

Dimension
320 x 190 mm

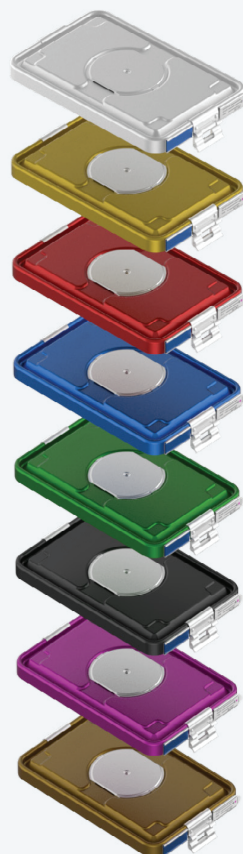

Reusable Model

Dental Size Baskets

Wire Basket

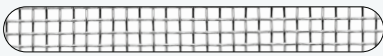

Mesh: \varnothing 4x4 mm
Wire: \varnothing 1 mm



Box



Lid

Code	Outside Dimension L x W x H
B1-2717-40	270 x 170 x 40 mm
B1-2717-100	270 x 170 x 100 mm

Code	Outside Dimension L x W x H
B1-2717	270 x 170 x 5 mm

Wire Basket

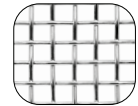

Perforated Basket

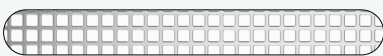

Mesh: \varnothing 4x4 mm
Wire: \varnothing 1 mm



Box (with 10 mm feet)



Lid

Code	Outside Dimension L x W x H
B2-2717-40	275 x 175 x 50 mm
B2-2717-100	275 x 175 x 110 mm

Code	Outside Dimension L x W x H
B2-2717	278 x 178 x 5 mm

Perforated Basket

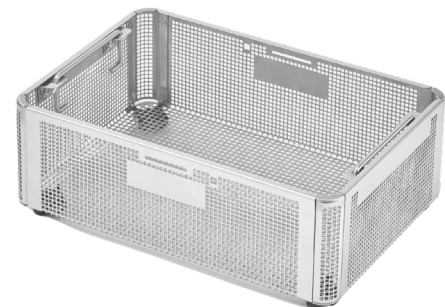
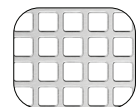

Reusable Model

1/2 Dental Size

 Different Lids Colors



With Reusable Mechanism

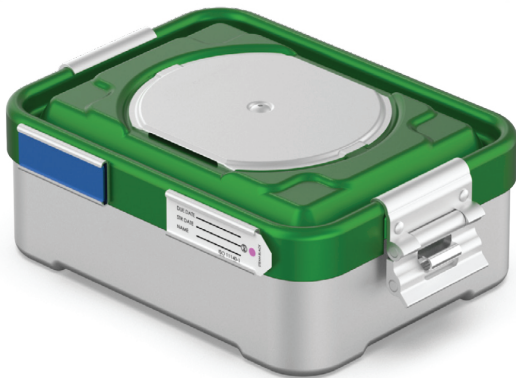

With Color Options



Non Perforated

Code **Outside Dimension**
Inside Dimension
L x W x H

K1-80-70 225 x 160 x 70 mm
190 x 157 x 60 mm

K1-80-100 225 x 160 x 100 mm
190 x 157 x 90 mm

K1-80-130 225 x 160 x 130 mm
190 x 157 x 120 mm

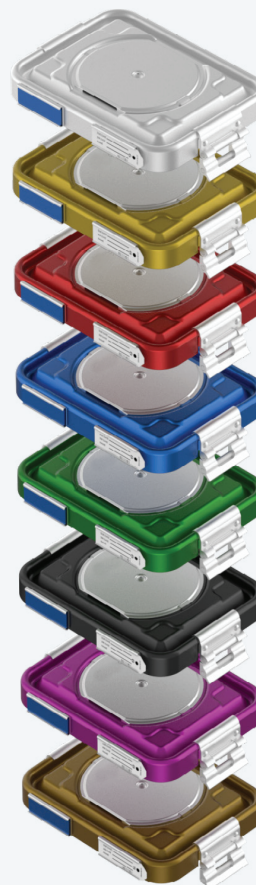

 **Lids**

Colors **Code**

Grey K3-80-1

Yellow K3-80-2

Red K3-80-3

Blue K3-80-4

Green K3-80-5

Black K3-80-6

Purple K3-80-7

Bronze K3-80-8

Dimension
230 x 175 mm

Reusable Model

1/2 Dental Size Baskets

Wire Basket

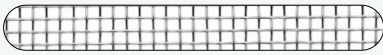

Mesh: \varnothing 4x4 mm
Wire: \varnothing 1 mm



Code	Outside Dimension L x W x H
B1-1714-40	175 x 145 x 40 mm
B1-1714-100	175 x 145 x 100 mm

Code	Outside Dimension L x W x H
B1-1714	175 x 145 x 5 mm

Perforated Basket



Mesh: \varnothing 4x4 mm
Wire: \varnothing 1 mm



Code	Outside Dimension L x W x H
B2-1714-40	175 x 145 x 50 mm
B2-1714-100	175 x 145 x 110 mm

Code	Outside Dimension L x W x H
B2-1714	178 x 148 x 5 mm

Wire Basket

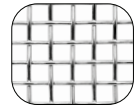

Perforated Basket

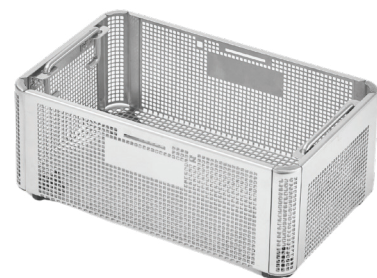
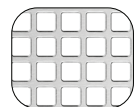

Sterilization Baskets

Sterilization Container Systems

SANITEV

Organize.

Sterilize.

Excel.

Holding the
Standard





Three Different Types of Basket Models by Construction/Material



Perforated Sheet

- Ø 1 mm
- 4 mm

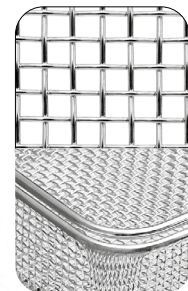

Wire Mesh

- Ø 1 mm
- 4 mm

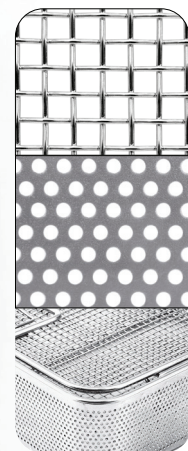

Hybrith

- Ø 1 mm
- 4 mm

Side Mesh
Ø 3 mm



Full Size

Box Code	Outside Dimension L x W x H
B1-5425-30	540 x 255 x 30 mm
B1-5425-50	540 x 255 x 50 mm
B1-5425-70	540 x 255 x 70 mm
B1-5425-100	540 x 255 x 100 mm

Lid Code	Outside Dimension L x W x H
B1-5425	510 x 240 x 5 mm

Din Size

Box Code	Outside Dimension L x W x H
B1-4825-30	485 x 255 x 30 mm
B1-4825-50	485 x 255 x 50 mm
B1-4825-70	485 x 255 x 70 mm
B1-4825-100	485 x 255 x 100 mm

Lid Code	Outside Dimension L x W x H
B1-4825	455 x 240 x 5 mm

Quarter Size

Box Code	Outside Dimension L x W x H
B1-4025-30	405 x 255 x 30 mm
B1-4025-50	405 x 255 x 50 mm
B1-4025-70	405 x 255 x 70 mm
B1-4025-100	405 x 255 x 100 mm

Lid Code	Outside Dimension L x W x H
B1-4025	375 x 240 x 5 mm

Half Size



Box Code	Outside Dimension L x W x H
B1-2525-30	255 x 245 x 30 mm
B1-2525-50	255 x 245 x 50 mm
B1-2525-70	255 x 245 x 70 mm
B1-2525-100	255 x 245 x 100 mm
Lid Code	Outside Dimension L x W x H
B1-2525	240 x 215 x 5 mm

Long Size

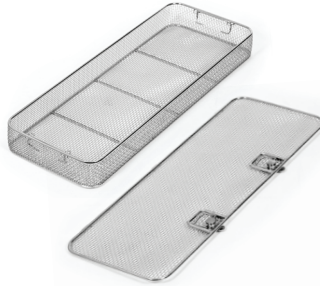

Box Code	Outside Dimension L x W x H
B1-6625-50	665 x 250 x 50 mm
B1-6625-70	665 x 250 x 70 mm
B1-6625-100	665 x 250 x 100 mm
-	-
Lid Code	Outside Dimension L x W x H
B1-6625	635 x 235 x 5 mm

Wide Size

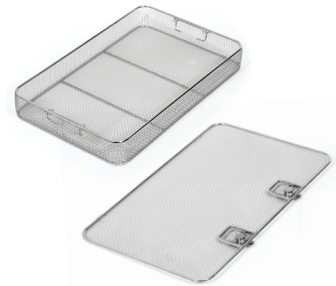

Box Code	Outside Dimension L x W x H
B1-5333-50	533 x 337 x 50 mm
B1-5333-70	533 x 337 x 70 mm
B1-5333-100	533 x 337 x 100 mm
-	-
Lid Code	Outside Dimension L x W x H
B1-5333	533 x 337 x 5 mm

Dental Size



Box Code	Outside Dimension L x W x H
B1-2717-40	270 x 170 x 40 mm
B1-2717-100	270 x 170 x 100 mm
-	-
-	-
Lid Code	Outside Dimension L x W x H
B1-2717	270 x 170 x 5 mm

Mini Size

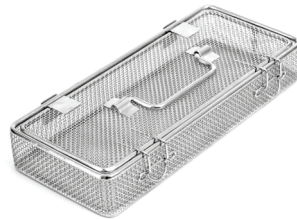

Box Code	Outside Dimension L x W x H
B1-2712-40	270 x 117 x 40 mm
B1-2712-100	270 x 117 x 100 mm
-	-
-	-
Lid Code	Outside Dimension L x W x H
B1-2712	270 x 117 x 5 mm

Dental 1/2



Box Code	Outside Dimension L x W x H
B1-1714-40	175 x 145 x 40 mm
B1-1714-100	175 x 145 x 100 mm
-	-
-	-
Lid Code	Outside Dimension L x W x H
B1-1714	175 x 145 x 5 mm

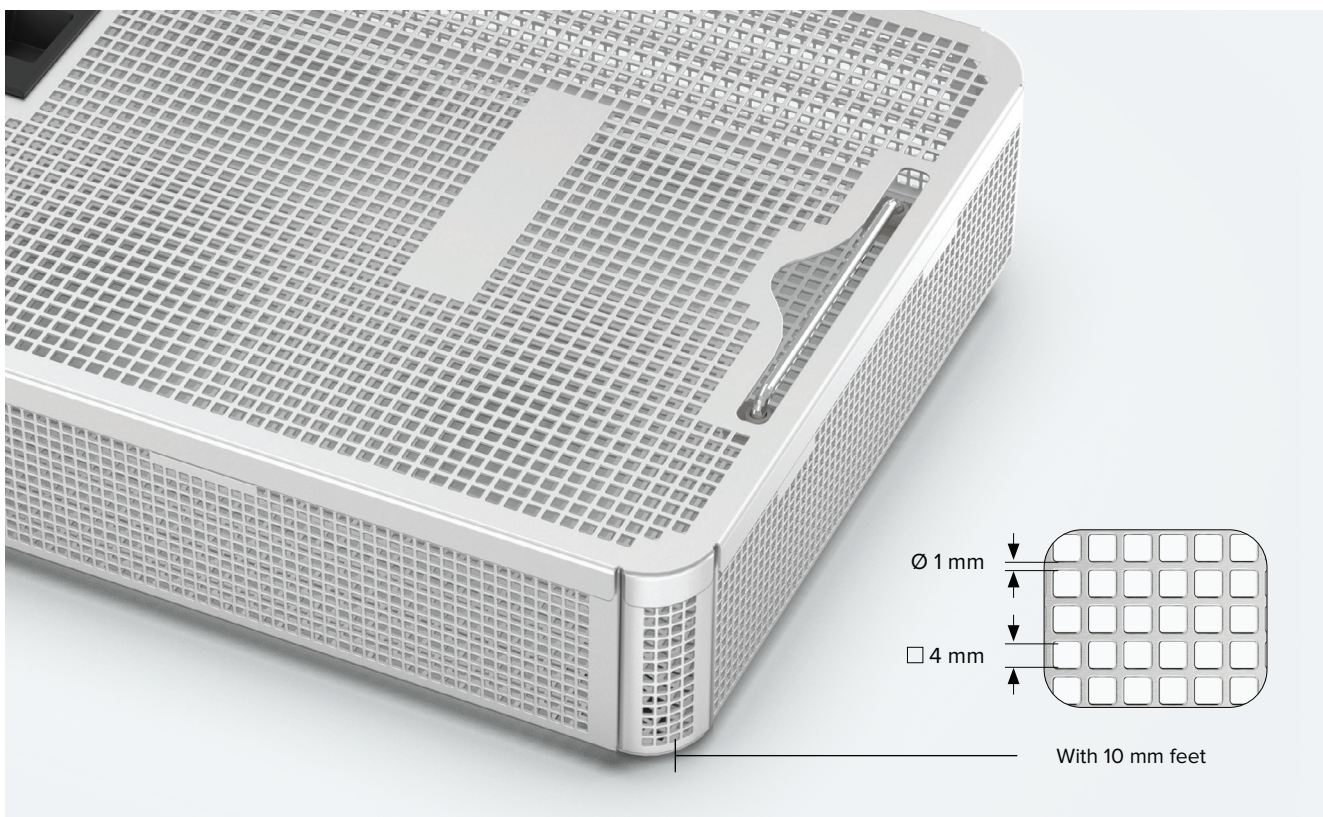

Full Size

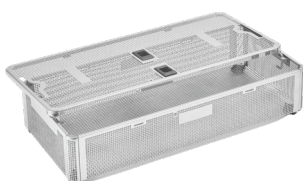

Box Code	Outside Dimension L x W x H
B2-5425-30	540 x 255 x 40 mm
B2-5425-50	540 x 255 x 60 mm
B2-5425-70	540 x 255 x 80 mm
B2-5425-100	540 x 255 x 110 mm

Lid Code	Outside Dimension L x W x H
B2-5425	543 x 256 x 5 mm

Din Size

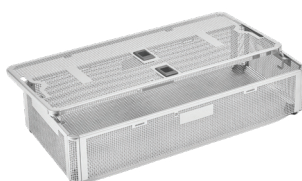

Box Code	Outside Dimension L x W x H
B2-4825-30	484 x 252 x 40 mm
B2-4825-50	484 x 252 x 60 mm
B2-4825-70	484 x 252 x 80 mm
B2-4825-100	484 x 252 x 110 mm

Lid Code	Outside Dimension L x W x H
B2-4825	488 x 256 x 5 mm

Quarter Size

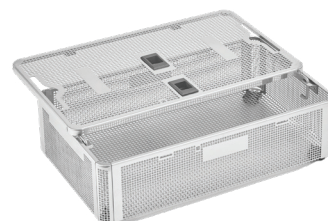

Box Code	Outside Dimension L x W x H
B2-4025-30	405 x 252 x 40 mm
B2-4025-50	405 x 252 x 60 mm
B2-4025-70	405 x 252 x 80 mm
B2-4025-100	405 x 252 x 110 mm

Lid Code	Outside Dimension L x W x H
B2-4025	409 x 256 x 5 mm

Half Size

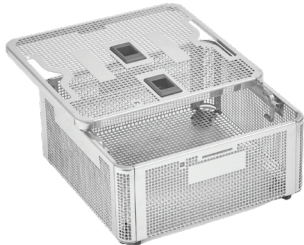

Box Code	Outside Dimension L x W x H
B2-2525-30	242 x 252 x 40 mm
B2-2525-50	242 x 252 x 60 mm
B2-2525-70	242 x 252 x 80 mm
B2-2525-100	242 x 252 x 110 mm

Lid Code	Outside Dimension L x W x H
B2-2525	246 x 256 x 5 mm

Long Size

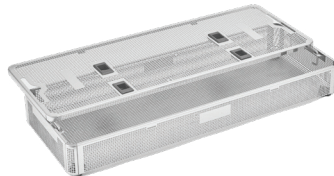

Box Code	Outside Dimension L x W x H
B2-6625-30	665 x 253 x 40 mm
B2-6625-50	665 x 253 x 60 mm
B2-6625-70	665 x 253 x 80 mm
B2-6625-100	665 x 253 x 110 mm

Lid Code	Outside Dimension L x W x H
B2-6625	668 x 256 x 5 mm

Wide Size

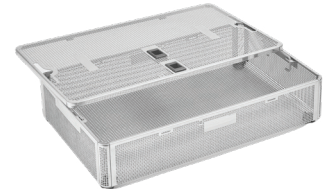

Box Code	Outside Dimension L x W x H
B2-5333-30	533 x 339 x 40 mm
B2-5333-50	533 x 339 x 60 mm
B2-5333-70	533 x 339 x 80 mm
B2-5333-100	533 x 339 x 110 mm

Lid Code	Outside Dimension L x W x H
B2-5333	536 x 343 x 5 mm

Dental Size

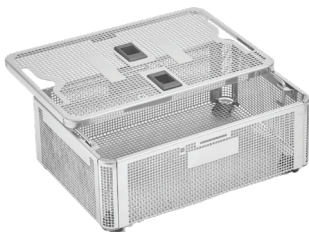

Box Code	Outside Dimension L x W x H
B2-2717-40	275 x 175 x 50 mm
B2-2717-100	275 x 175 x 110 mm
-	-
-	-

Lid Code	Outside Dimension L x W x H
B2-2717	278 x 178 x 5 mm

Mini Size



Box Code	Outside Dimension L x W x H
B2-2712-40	265 x 125 x 50 mm
B2-2712-100	265 x 125 x 110 mm
-	-
-	-

Lid Code	Outside Dimension L x W x H
B2-2712	268 x 128 x 5 mm

Dental 1/2

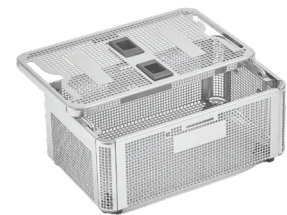

Box Code	Outside Dimension L x W x H
B2-1714-40	175 x 145 x 50 mm
B2-1714-100	175 x 145 x 110 mm
-	-
-	-

Lid Code	Outside Dimension L x W x H
B2-1714	178 x 148 x 5 mm



Full Size



Box Code	Outside Dimension L x W x H
B3-5425-50	540 x 255 x 50 mm
B3-5425-70	540 x 255 x 70 mm
B3-5425-100	540 x 255 x 100 mm

Lid Code	Outside Dimension L x W x H
B1-5425	540 x 245 x 5 mm

Din Size



Box Code	Outside Dimension L x W x H
B3-4825-50	484 x 252 x 40 mm
B3-4825-70	484 x 252 x 70 mm
B3-4825-100	484 x 252 x 100 mm

Lid Code	Outside Dimension L x W x H
B1-4825	485 x 245 x 5 mm

Quarter Size



Box Code	Outside Dimension L x W x H
B3-4025-50	405 x 252 x 45 mm
B3-4025-70	405 x 252 x 70 mm
B3-4025-100	405 x 252 x 100 mm

Lid Code	Outside Dimension L x W x H
B1-4025	405 x 245 x 5 mm

Half Size



Box Code	Outside Dimension L x W x H
B3-2525-50	245 x 245 x 50 mm
B3-2525-70	245 x 245 x 70 mm
B3-2525-100	245 x 245 x 100 mm

Lid Code	Outside Dimension L x W x H
B1-2525	245 x 245 x 5 mm

Long Size



Box Code	Outside Dimension L x W x H
B3-6625-50	665 x 245 x 50 mm
B3-6625-70	665 x 245 x 70 mm
B3-6625-100	665 x 245 x 100 mm

Lid Code	Outside Dimension L x W x H
B1-6625	665 x 245 x 5 mm

Wide Size



Box Code	Outside Dimension L x W x H
B3-5333-50	533 x 337 x 50 mm
B3-5333-70	533 x 337 x 70 mm
B3-5333-100	533 x 337 x 100 mm

Lid Code	Outside Dimension L x W x H
B1-5333	533 x 337 x 5 mm

Fine Mesh Baskets

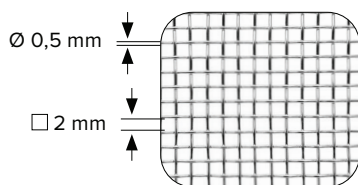
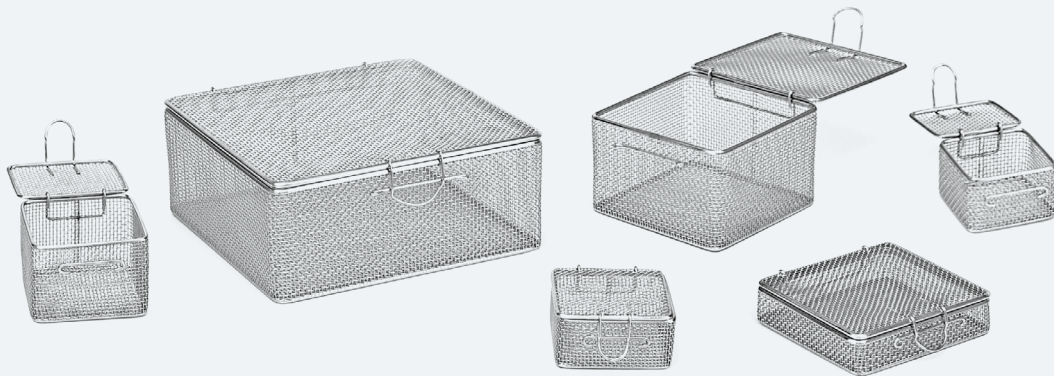

Box Code	Outside Dimension L x W x H
B4-33-30	30 x 30 x 30 mm
B4-44-20	40 x 40 x 20 mm
B4-66-20	60 x 60 x 20 mm
B4-66-40	60 x 60 x 40 mm
B4-84-40	80 x 40 x 40 mm

Box Code	Outside Dimension L x W x H
B4-88-40	80 x 80 x 40 mm
B4-88-60	80 x 80 x 60 mm
B4-1212-30	120 x 120 x 30 mm
B4-1212-60	120 x 120 x 60 mm
B4-2424-60	240 x 240 x 60 mm



Wire Basket Single Scope

Code

B5-298-55-S

Dimension

L x W x H
290 x 80 x 55 mm

Code

B5-468-55-S

Dimension

L x W x H
460 x 80 x 55 mm

Wire Basket Double Scope

Code

B5-298-55-D

Dimension

L x W x H
290 x 80 x 55 mm

Code

B5-468-55-D

Dimension

L x W x H
460 x 80 x 55 mm

Perforated Basket Single Scope

Code

B5-278-44-S

Dimension

L x W x H
290 x 80 x 55 mm

Code

B5-458-44-S

Dimension

L x W x H
452 x 83 x 44 mm

Perforated Basket Double Scope

Code

B5-2710-44-D

Dimension

L x W x H
290 x 80 x 55 mm

Code

B5-4510-44-D

Dimension

L x W x H
452 x 83 x 44 mm

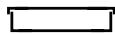
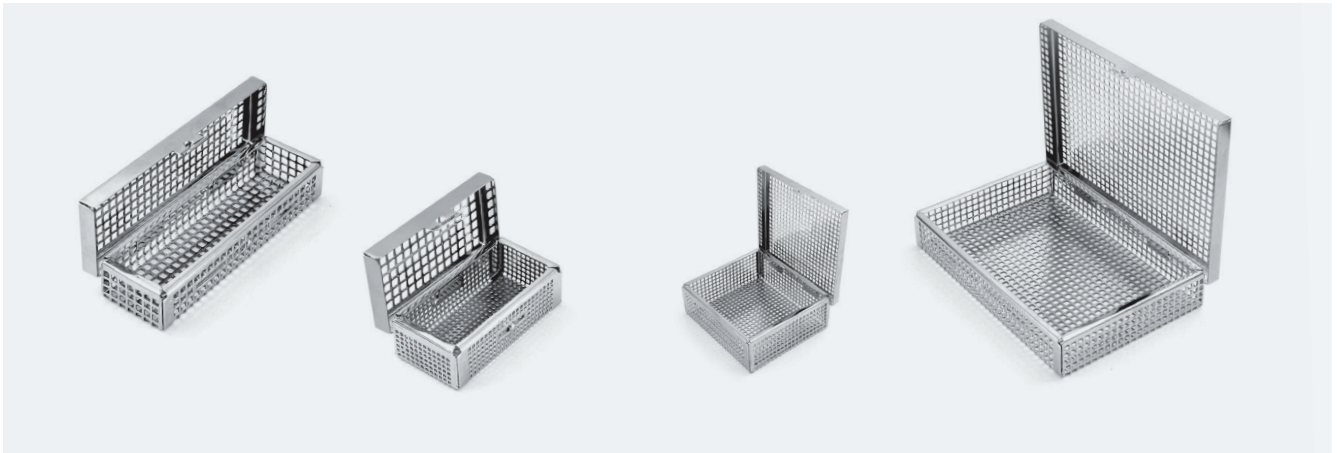

Bottom With Lid

W/O Feet

Wire: \varnothing 1 mm

Mesh: 4x4 mm

Code	Dimension L x W x H	Code	Dimension L x W x H
B2-2718-32	275 x 180 x 32 mm	B2-188-32	188 x 86 x 32 mm
B2-2718-42	275 x 180 x 42 mm	B2-144-28	146 x 46 x 28 mm
B2-247-30	240 x 76 x 30 mm	B2-84-28	86 x 46 x 28 mm
B2-1913-34	190 x 130 x 34 mm		

STU - SPRI Baskets

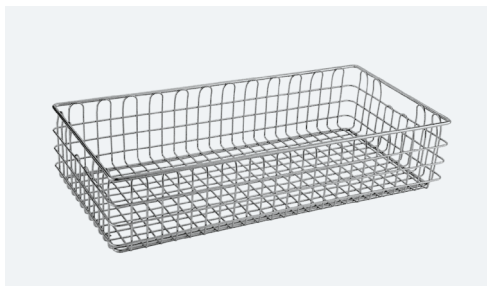

STU Baskets

Box Code	Outside Dimension L x W x H	Details
B7-5728-135	575 x 280 x 135 mm	Upper Frame: \varnothing 6 mm
B7-5728-265	575 x 280 x 265 mm	Body Wires: \varnothing 2 & 3 mm Base Frame \varnothing 5 mm

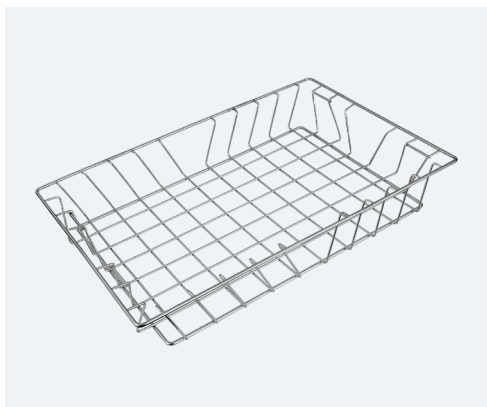

SPRI Baskets

Box Code	Outside Dimension L x W x H	Details
B8-6030-40	600x300x40 mm	Main Frame: \varnothing 6 mm
B8-6030-100	600x300x100 mm	Body Wire: \varnothing 4 mm
B8-6030-150	600x300x150 mm	Base Frame \varnothing 5 mm
B8-6040-100	600x400x100 mm	Single Frame Stackable
B8-6040-150	600x400x150 mm	
B8-6040-200	600x400x200 mm	



Paper Filters	
Code A1-10-1 For: 1/1, 3/4, 1/2, Long, Wide Size: Ø 185 mm	Code A1-11-1 For: Small Size Containers Size: Ø 88 mm
Material 73g/m ² Medical Grade Paper Package 100 pcs Sterilization Steam Cycle Single Use	

PTFE Teflon Filters	
Code A1-20-1 For: 1/1, 3/4, 1/2, Long, Wide Size: Ø 185 mm	Code A1-21-1 For: Small Size Containers Size: Ø 88 mm
Material 1 mm (± 0,25) PTFE Package 1 Piece Sterilization Steam & EtO Cycle 2000 Cycle Reusable	

Polymer Security Seals	
Code A2-10-1 Package 100 pcs Sterilization Steam Cycle Single Use Color Blue	Code A2-20-1 Package 100 pcs Sterilization Steam Cycle Single Use Color Red

Polymer Security Seals With Indicator	
Code A2-10-2 Package 100 pcs Sterilization Steam Cycle Single Use Color Blue	Code A2-20-2 Package 100 pcs Sterilization Steam Cycle Single Use Color Red



Identification Labels

Color	Code	Color	Code		
	A5-10-1		A5-10-5	Material	1,5 mm Aluminum
	A5-10-2		A5-10-6	Package	1 Piece
	A5-10-3		A5-10-7	Sterilization	Steam
	A5-10-4		A5-10-8	Marking	Maximum 24 Letters

Filter Retainers

Code A6-10-1 For: 1/1, 3/4, 1/2, Long, Wide	Code A6-10-2 For: Small Size Containers
Material	Stainless Steel
Package	1 piece

Paper Labels

		Material	Paper
Code A3-10-1 with indicator	Code A3-10-2 with indicator	Size	Big & Small
		Package	100 pcs
		Sterilization	Steam

Silicone Mats & Nets

	<table border="1"> <thead> <tr> <th>Code</th> <th>Size</th> </tr> </thead> <tbody> <tr> <td>A7-5425</td> <td>500 X 235 mm</td> </tr> <tr> <td>A7-4025</td> <td>370 X 235 mm</td> </tr> <tr> <td>A7-2525</td> <td>225 x 235 mm</td> </tr> <tr> <td>A7-2712</td> <td>270 x 125 mm</td> </tr> </tbody> </table>	Code	Size	A7-5425	500 X 235 mm	A7-4025	370 X 235 mm	A7-2525	225 x 235 mm	A7-2712	270 x 125 mm		<table border="1"> <thead> <tr> <th>Code</th> <th>Size</th> </tr> </thead> <tbody> <tr> <td>A4-5425</td> <td>520 x 242 mm</td> </tr> <tr> <td>A4-4025</td> <td>380 x 242 mm</td> </tr> <tr> <td>A4-2525</td> <td>255 x 250 mm</td> </tr> </tbody> </table>	Code	Size	A4-5425	520 x 242 mm	A4-4025	380 x 242 mm	A4-2525	255 x 250 mm
Code	Size																				
A7-5425	500 X 235 mm																				
A7-4025	370 X 235 mm																				
A7-2525	225 x 235 mm																				
A7-2712	270 x 125 mm																				
Code	Size																				
A4-5425	520 x 242 mm																				
A4-4025	380 x 242 mm																				
A4-2525	255 x 250 mm																				
	<table border="1"> <tbody> <tr> <td>h: 14 mm</td> </tr> <tr> <td>h: 5 mm</td> </tr> <tr> <td>h: 2 mm</td> </tr> </tbody> </table>	h: 14 mm	h: 5 mm	h: 2 mm	Material	Medical Grade Silicone															
h: 14 mm																					
h: 5 mm																					
h: 2 mm																					
		Package	1 Piece																		
		Sterilization	Steam																		
		Color	Light Blue																		

Silicone Gasket

	<table border="1"> <thead> <tr> <th>Code</th> <th>Size</th> <th>Code</th> <th>Size</th> <th>Code</th> <th>Size</th> </tr> </thead> <tbody> <tr> <td>A11-10-1</td> <td>1/1 Full</td> <td>A11-40-1</td> <td>Long</td> <td>A11-70-1</td> <td>Mini</td> </tr> <tr> <td>A11-20-1</td> <td>3/4 Quarter</td> <td>A11-50-1</td> <td>Wide</td> <td>A11-80-1</td> <td>1/2 Dental</td> </tr> <tr> <td>A11-30-1</td> <td>1/2 Half</td> <td>A11-60-1</td> <td>Dental</td> <td>A11-90-1</td> <td>Flat</td> </tr> </tbody> </table>	Code	Size	Code	Size	Code	Size	A11-10-1	1/1 Full	A11-40-1	Long	A11-70-1	Mini	A11-20-1	3/4 Quarter	A11-50-1	Wide	A11-80-1	1/2 Dental	A11-30-1	1/2 Half	A11-60-1	Dental	A11-90-1	Flat	Material	Medical Grade Sealing Silicone
Code	Size	Code	Size	Code	Size																						
A11-10-1	1/1 Full	A11-40-1	Long	A11-70-1	Mini																						
A11-20-1	3/4 Quarter	A11-50-1	Wide	A11-80-1	1/2 Dental																						
A11-30-1	1/2 Half	A11-60-1	Dental	A11-90-1	Flat																						
		Package	1 Piece																								
		Shape	D shape, Jointless																								
		Feature	Place & Go, No Glue Required																								



Code T1-10-1
 Material : Stainless Steel
 Feet : 4 wheels - 2 braked
 Package : 1 Piece
 Dimensions: 600 x 860 x 900 mm (W x L x H)



Code T1-10-2
 Material : Stainless Steel
 Feet : 4 wheels - 2 braked
 Package : 1 Piece
 Dimensions: 550 x 860 x 900 mm (W x L x H)



Code T1-10-3
 Material : Stainless Steel
 Feet : 4 wheels - 2 braked
 Package : 1 Piece
 Dimensions: 600 x 850 x 900 mm (W x L x H)



Code T1-10-4
 Material : Stainless Steel
 Feet : 4 wheels - 2 braked
 Package : 1 Piece
 Dimensions: 550 x 860 x 900 mm (W x L x H)



Code T1-10-5
 Material : Stainless Steel
 Feet : 4 Adjustable Leveling Feet
 Package : 1 Piece
 Dimensions: 600 x 1400 x 850 mm (W x L x H)



Code T1-10-6
 Material : Stainless Steel
 Feet : 4 wheels - 2 braked
 Package : 1 Piece
 Dimensions: 700 x 360 x 1350 mm (W x L x H)

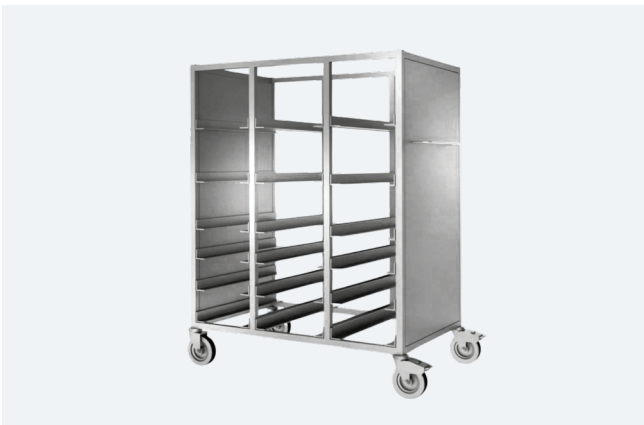

Code T1-10-7
 Material : Stainless Steel
 Feet : 4 wheels - 2 braked
 Package : 1 Piece
 Dimensions: 700 x 360 x 1350 mm (W x L x H)



Code T1-10-8
 Material : Stainless Steel
 Feet : 4 wheels - 2 braked
 Package : 1 Piece - including 3 baskets
 Dimensions: 400 x 600 x 1700 (W x L x H)

Code	Page	Code	Page	Code	Page	Code	Page
A1-10-1	68	B1-6625-100	25, 47, 61	B3-5425-50	19, 41, 65	K1-30-6	22
A11-10-1	69	B1-6625-50	25, 47, 61	B3-5425-70	19, 41, 65	K1-30-7	22
A1-11-1	68	B1-6625-70	25, 47, 61	B3-6625	25, 47, 65	K1-30-8	22
A11-20-1	69	B2-144-28	67	B3-6625-100	25, 47, 65	K1-40-1	24
A11-30-1	69	B2-1714	35, 57, 63	B3-6625-50	25, 47, 65	K1-40-150	24, 46
A11-40-1	69	B2-1714-100	35, 57, 63	B3-6625-70	25, 47, 65	K1-40-2	24
A11-50-1	69	B2-1714-40	35, 57, 63	B4-1212-30	65	K1-40-200	24, 46
A11-60-1	69	B2-188-32	67	B4-1212-60	65	K1-40-3	24
A11-70-1	69	B2-1913-34	67	B4-2424-60	65	K1-40-4	24
A11-80-1	69	B2-247-30	67	B4-33-30	65	K1-40-5	24
A11-90-1	69	B2-2525	23, 29, 45, 51, 61	B4-44-20	65	K1-40-6	24
A1-20-1	68	B2-2525-100	23, 45, 61	B4-66-20	65	K1-40-7	24
A1-21-1	68	B2-2525-30	23, 29, 45, 51, 61	B4-66-40	65	K1-40-8	24
A2-10-1	68	B2-2525-50	23, 29, 45, 51, 61	B4-84-40	65	K1-50-1	26
A2-10-2	68	B2-2525-70	23, 45, 61	B4-88-40	65	K1-50-110	26, 48
A2-20-1	68	B2-2712	31,53,63	B4-88-60	65	K1-50-170	26, 48
A2-20-2	68	B2-2712-100	31,53,63	B5-2710-44-D	66	K1-50-2	26
A3-10-1	69	B2-2712-40	31,53,63	B5-278-44-S	66	K1-50-3	26
A3-10-2	69	B2-2717	35, 57, 63	B5-298-55-D	66	K1-50-4	26
A5-10-1	69	B2-2717-100	35, 57, 63	B5-298-55-S	66	K1-50-5	26
A5-10-2	69	B2-2717-40	35, 57, 63	B5-4510-44-D	66	K1-50-6	26
A5-10-3	69	B2-2718-32	67	B5-458-44-S	66	K1-50-7	26
A5-10-4	69	B2-2718-42	67	B5-468-55-S	66	K1-50-8	26
A5-10-5	69	B2-4025	21, 43, 62	B5-468-55-D	66	K1-60-1	32
A5-10-6	69	B2-4025-100	21, 43, 62	B7-5728-135	67	K1-60-100	32, 54
A5-10-7	69	B2-4025-30	21, 43, 62	B7-5728-265	67	K1-60-130	32, 54
A5-10-8	69	B2-4025-50	21, 43, 62	B8-6030-100	67	K1-60-2	32
A6-10-1	69	B2-4025-70	21, 43, 62	B8-6030-150	67	K1-60-3	32
A6-10-2	69	B2-4825	62	B8-6030-40	67	K1-60-4	32
A7-2525	22, 29, 45, 51, 69	B2-4825-100	62	B8-6040-100	67	K1-60-40	32
A7-2712	31, 53, 69	B2-4825-30	62	B8-6040-150	67	K1-60-5	32
A7-4025	21 43 69	B2-4825-50	62	B8-6040-200	67	K1-60-6	32
A7-5425	19, 41, 69	B2-4825-70	62	K1-10-1	18	K1-60-7	32
B1-1714	35, 57, 63	B2-5333	27, 49, 63	K1-10-110	18, 40	K1-60-70	32, 55
B1-1714-100	35, 57, 63	B2-5333-100	27, 49, 63	K1-10-135	18, 40	K1-60-8	32
B1-1714-40	35, 57, 63	B2-5333-30	27, 49, 63	K1-10-150	18, 40	K1-70-1	32
B1-2525	23, 29, 45, 51, 61, 65	B2-5333-50	27, 49, 63	K1-10-2	18	K1-70-100	32, 55
B1-2525-100	23, 45, 61	B2-5333-70	27, 49, 63	K1-10-200	18, 40	K1-70-130	32, 55
B1-2525-30	23, 29, 45, 51, 61	B2-5425	19,41, 62	K1-10-260	18, 40	K1-70-2	32
B1-2525-50	23, 29, 45, 51, 61	B2-5425-100	19,41, 62	K1-10-3	18	K1-70-3	32
B1-2525-70	23, 45, 61	B2-5425-30	19,41, 62	K1-10-4	18	K1-70-4	32
B1-2712	31, 53, 61	B2-5425-50	19,41, 62	K1-10-5	18	K1-70-40	32
B1-2712-100	31, 53, 61	B2-5425-70	19,41, 62	K1-10-6	18	K1-70-5	32,32
B1-2712-40	31, 53, 61	B2-6625	25, 47, 63	K1-10-7	18	K1-70-6	32
B1-2717	33, 55 61	B2-6625-100	25, 47, 63	K1-10-8	18	K1-70-7	32
B1-2717-100	33, 55 61	B2-6625-30	25, 47, 63	K1-20-1	20	K1-70-70	32, 55
B1-2717-40	33, 55 61	B2-6625-50	25, 47, 63	K1-20-110	20, 42	K1-70-8	32
B1-4025	21, 43, 60, 64	B2-6625-70	25, 47, 63	K1-20-135	20, 42	K1-80-1	34
B1-4025-100	21, 43, 60	B2-84-28	67	K1-20-150	20, 42	K1-80-100	34, 56
B1-4025-30	21, 43, 60	B3-2525	23, 45, 65	K1-20-2	20	K1-80-130	34, 56
B1-4025-50	21, 43, 60	B3-2525-100	23, 45, 65	K1-20-200	20, 42	K1-80-2	34
B1-4025-70	21, 43, 60	B3-2525-50	23, 45, 65	K1-20-3	20	K1-80-3	34
B1-4825	60, 64	B3-2525-70	23, 45, 65	K1-20-4	20	K1-80-4	34
B1-4825-100	60	B3-4025	21, 45, 65	K1-20-5	20	K1-80-40	34
B1-4825-30	60	B3-4025-100	21, 43, 65	K1-20-6	20	K1-80-5	34
B1-4825-50	60	B3-4025-50	21, 43, 65	K1-20-7	20	K1-80-6	34
B1-4825-70	60	B3-4025-70	21, 43, 65	K1-20-8	20	K1-80-7	34
B1-5333	27, 49, 61	B3-4825	67	K1-30-1	22	K1-80-70	34, 56
B1-5333-100	27, 49, 61	B3-4825-100	67	K1-30-110	22, 44	K1-80-8	34
B1-5333-50	27, 49, 61	B3-4825-50	67	K1-30-135	22, 44	K1-90-1	28
B1-5333-70	27, 49, 61	B3-4825-70	67	K1-30-150	22, 44	K1-90-2	28
B1-5425	19, 41, 60, 64	B3-5333	27, 49, 65	K1-30-2	22	K1-90-3	28
B1-5425-100	19,41, 60	B3-5333-100	27, 49, 65	K1-30-200	22, 44	K1-90-4	28
B1-5425-30	19,41, 60	B3-5333-50	27, 49, 65	K1-30-260	22, 44	K1-90-45	28
B1-5425-50	19,41, 60	B3-5333-70	27, 49, 65	K1-30-3	22	K1-90-5	28
B1-5425-70	19,41, 60	B3-5425	19, 41, 65	K1-30-4	22	K1-90-6	28
B1-6625	25, 47, 61, 65	B3-5425-100	19, 41, 65	K1-30-5	22	K1-90-7	28

Code	Page	Code	Page	Code	Page
K1-90-75	28, 50	K3-40-2	46	KS1-10-3	18
K1-90-8	28	K3-40-3	46	KS1-10-4	18
K2-10-1	40	K3-40-4	46	KS1-10-5	18
K2-10-2	40	K3-40-5	46	KS1-10-6	18
K2-10-3	40	K3-40-6	46	KS1-10-7	18
K2-10-4	40	K3-40-7	46	KS1-10-8	18
K2-10-5	40	K3-40-8	46	KS1-20-1	20
K2-10-6	40	K3-50-1	48	KS1-20-2	20
K2-10-7	40	K3-50-2	48	KS1-20-3	20
K2-10-8	40	K3-50-3	48	KS1-20-4	20
K2-20-1	42	K3-50-4	48	KS1-20-5	20
K2-20-2	42	K3-50-5	48	KS1-20-6	20
K2-20-3	42	K3-50-6	48	KS1-20-7	20
K2-20-4	42	K3-50-7	48	KS1-20-8	20
K2-20-5	42	K3-50-8	48	KS1-30-1	22
K2-20-6	42	K3-60-1	54	KS1-30-2	22
K2-20-7	42	K3-60-2	54	KS1-30-3	22
K2-20-8	42	K3-60-3	54	KS1-30-4	22
K2-30-1	44	K3-60-4	54	KS1-30-5	22
K2-30-2	44	K3-60-5	54	KS1-30-6	22
K2-30-3	44	K3-60-6	54	KS1-30-7	22
K2-30-4	44	K3-60-7	54	KS1-30-8	22
K2-30-5	44	K3-60-8	54	T1-10-1	70
K2-30-6	44	K3-70-1	52	T1-10-2	70
K2-30-7	44	K3-70-2	52	T1-10-3	70
K2-30-8	44	K3-70-3	52	T1-10-4	70
K2-40-1	46	K3-70-4	52	T1-10-5	71
K2-40-2	46	K3-70-5	52	T1-10-6	71
K2-40-3	46	K3-70-6	52	T1-10-7	71
K2-40-4	46	K3-70-7	52	T1-10-8	71
K2-40-5	46	K3-70-8	52		
K2-40-6	46	K3-80-1	56		
K2-40-7	46	K3-80-2	56		
K2-40-8	46	K3-80-3	56		
K2-50-1	48	K3-80-4	56		
K2-50-2	48	K3-80-5	56		
K2-50-3	48	K3-80-6	56		
K2-50-4	48	K3-80-7	56		
K2-50-5	48	K3-80-8	56		
K2-50-6	48	K3-90-1	50		
K2-50-7	48	K3-90-2	50		
K2-50-8	48	K3-90-3	50		
K3-10-1	40	K3-90-4	50		
K3-10-2	40	K3-90-5	50		
K3-10-3	40	K3-90-6	50		
K3-10-4	40	K3-90-7	50		
K3-10-5	40	K3-90-8	50		
K3-10-6	40	KP1-10-110	18		
K3-10-7	40	KP1-10-135	18		
K3-10-8	40	KP1-10-150	18		
K3-20-1	42	KP1-10-200	18		
K3-20-2	42	KP1-10-260	18		
K3-20-3	42	KP1-20-110	20		
K3-20-4	42	KP1-20-135	20		
K3-20-5	42	KP1-20-150	20		
K3-20-6	42	KP1-20-200	20		
K3-20-7	42	KP1-30-110	22		
K3-20-8	42	KP1-30-135	22		
K3-30-1	44	KP1-30-150	22		
K3-30-2	44	KP1-30-200	22		
K3-30-3	44	KP1-30-260	22		
K3-30-4	44	KP1-40-150	24		
K3-30-5	44	KP1-40-200	24		
K3-30-6	44	KP1-50-110	26		
K3-30-7	44	KP1-50-170	26		
K3-30-8	44	KS1-10-1	18		
K3-40-1	46	KS1-10-2	18		

SANITEV

Cumhuriyet Mah. 28. Sok. No 32/7
Atakum/Samsun/Türkiye

+90 546 426 15 55
www.sanitev.com
sales@sanitev.com

All rights reserved. No part of this catalog may be reproduced, copied,
or published in any form without the written permission of